

MST-02MH00-A1000U



MST, Fiber Optic Multiport Service Terminal, 2-port, long 2xN port, dielectric flat loose tube cable, 1000 ft

- Hardened connectors are factory-terminated and environmentally sealed for use in optical drop cable deployments
- Plug-and-play adapter ports ensure rapid cable installment in the outside plant access section of the network
- Multiport Service Terminals incorporate hardened connector technology that is designed to withstand the rugged outside plant environment

Product Classification

Product Type	Access terminal, without splitter/tap
Product Series	MST
Regional Availability	Asia Latin America North America

General Specifications

Distribution Type	2 ports
Port, quantity	2
Cable Type	Dielectric - Flat - Loose Tube
Port Type	Hardened full-size SC/APC
Stub Type	Stub tail
Cable, quantity	1
Enclosure Color	Black
Includes	Enclosure (1) Universal mounting bracket (1)
Package, quantity	1
Packaging Type	Box Carton
Splitter, quantity	0

Dimensions

Cable Length	304.80 m 1000.00 ft
Depth	84.10 mm 3.31 in
Height	282.40 mm 11.12 in
Outer Cable Dimensions	4.5 x 8.1 mm (1.78 x 0.32 in)
Weight, without cable	0.86 kg 1.90 lb
Width	129.50 mm 5.10 in

Dimension Drawing

MST-02MH00-A1000U

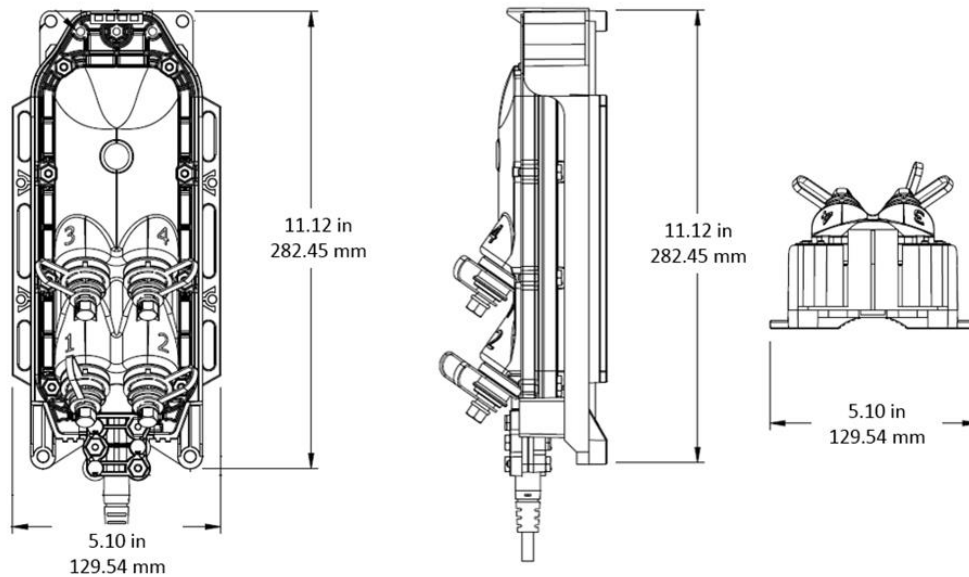

Mechanical Specifications

Enclosure Material Type

Gasketed hardened plastic

Mount Type

Handhole | Pedestal | Pole | Strand

Optical Specifications

Attenuation at Length, maximum

0.30 dB/km @ 1550 nm | 0.40 dB/km @ 1310 nm

Directivity, minimum

60 dB

Fiber Type

G.652.D

Insertion Loss, Terminal Connector, maximum

0.40 dB

Insertion Loss, Terminal Connector, typical

0.16 dB

Return Loss, Connector, minimum

65 dB

Wavelength Range

1260–1635 nm

Environmental Specifications

Environmental Space

Above ground | Below ground | Buried

Flammability Rating

UL 94 5VA

Operating Temperature

-40 °C to +70 °C (-40 °F to +158 °F)

Qualification Standard

IEC 60529, IP68 + 2 m waterhead | Telcordia GR-3120-CORE | Telcordia GR-326-CORE | Telcordia GR-771-CORE

Relative Humidity

5%–95%, non-condensing

UV Resistance

UV stabilized

MST-02MH00-A1000U

Regulatory Compliance/Certifications

Agency

RoHS 2011/65/EU

ISO 9001:2015

Classification

Compliant

Designed, manufactured and/or distributed under this quality management system



Included Products

MST-UMB-0204 — DLX® MST, Fiber Optic Universal Mounting Bracket, 2/4 port