



FIST™ GCO2 Fiber Optic Splice Closure, Heat Shrink Cable sealing, size BE, no pre-installed fiber trays, 6 ports

- Single-ended, O-ring sealed dome closure for splicing feeder and distribution cables
- Compatible with most common cable types: e.g. loose tube, central core, ribbon fiber
- Universal mounting system (UMS) profiles provide foundation for mounting combinations of FIST splice trays
- Closure can be used in aerial, pedestal and underground (up to 5 meters) environments
- Compatible with CommScope's CWDM modules and optical splitter trays

Product Classification

Product Type	Single-ended, round fiber closure
Regional Availability	EMEA
Product Series	FIST-GCO2
Product Brand	FIST™

General Specifications

Splicing Type, Supported	Mass fusion Single fusion
Splicing Capacity, Mass Fusion, maximum	464
Splicing Capacity, Single Fusion, maximum	672
Color	Black
Network Area Type	Distribution
Package, quantity	1
Packaging Type	Box Carton
Splice Tray Included, quantity	0
Splicing Capacity, Single Splice, 12 fibers, maximum	672
Splicing Capacity, Single Splice, 2 fibers, maximum	224

Dimensions

Main Cable Diameter, maximum	25.00 mm
Cable Entry Drop Port Diameter	30 mm
Cable Entry Main Port Dimensions	30 mm x 82 mm (1.18 in x 3.23 in)
Diameter	247.00 mm 9.72 in
Diameter, with clamp	285 mm 11 in
Length	680.00 mm 26.77 in
Weight	5.20 kg 11.46 lb

Dimension Drawing

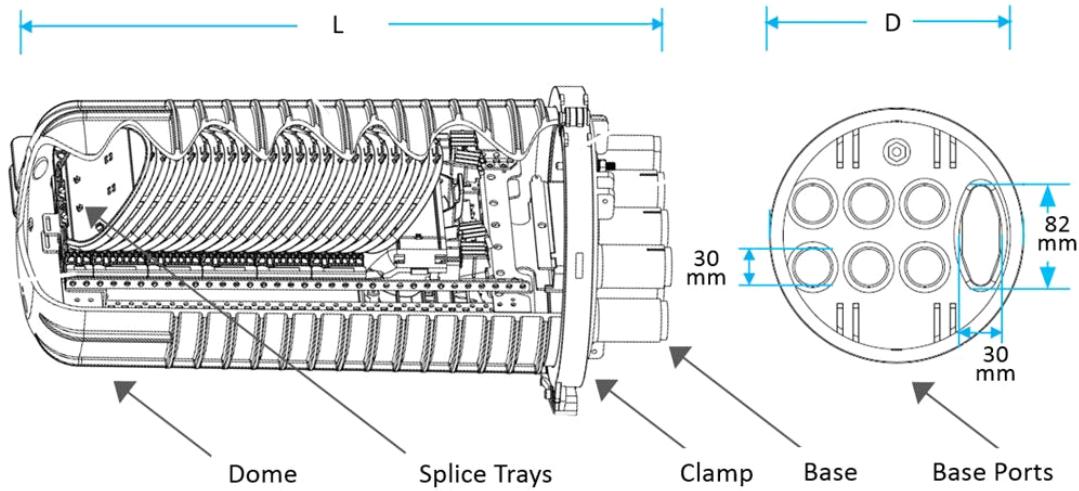

Mechanical Specifications

Cable Sealing Type	Gel kit (optional) Heat shrink
Cable Entry Drop Port Style	Round
Cable Entry Main Port Style	Oval
Cable Ports, quantity	7
Closure Sealing Type	Dome-to-base clamp with O-ring
Closure Style	Single-ended
Material Type	Impact-resistant polymer
Mount Type	Pole Strand Wall

Environmental Specifications

Environmental Space	Below ground Buried
Qualification Standard	IEC 61300, 5 m waterhead

Regulatory Compliance/Certifications

Agency	Classification
RoHS 2011/65/EU	Compliant
ISO 9001:2015	Designed, manufactured and/or distributed under this quality management system

