

# FST-R-04H00-G0300M



FST Flexible Service Terminal, 4 Port, 4 Full-size hardened Adapters at drop side, cable stub at feeder side, black, 300m long

- Flexible Service Terminals incorporate hardened connector technology that is designed to withstand the rugged outside plant environment
- Hardened connectors are factory-terminated and environmentally sealed for use in optical drop cable deployments
- Flexible structure plus very small branching unit, allowing installation in constrained spaces
- Output cables are staggered, optimizing distributed space consumption and minimizing cable kinking

## Product Classification

<b>Product Type</b>	Access terminal, without splitter/tap
<b>Product Series</b>	FST-R
<b>Regional Availability</b>	EMEA

## General Specifications

<b>Distribution Type</b>	4 ports
<b>Port, quantity</b>	4
<b>Cable Type</b>	Dielectric - Loose Tube
<b>Port Type</b>	Hardened full-size SC/APC
<b>Stub Type</b>	Stub tail
<b>Enclosure Color</b>	Black
<b>Minimum Order Quantity</b>	1
<b>Package, quantity</b>	1
<b>Packaging Type</b>	Box   Carton
<b>Splitter, quantity</b>	0

## Dimensions

<b>Cable Length</b>	300.00 m   984.25 ft
<b>Outer Cable Dimensions</b>	5.5 mm (0.22 in)

# FST-R-04H00-G0300M

## Dimension Drawing

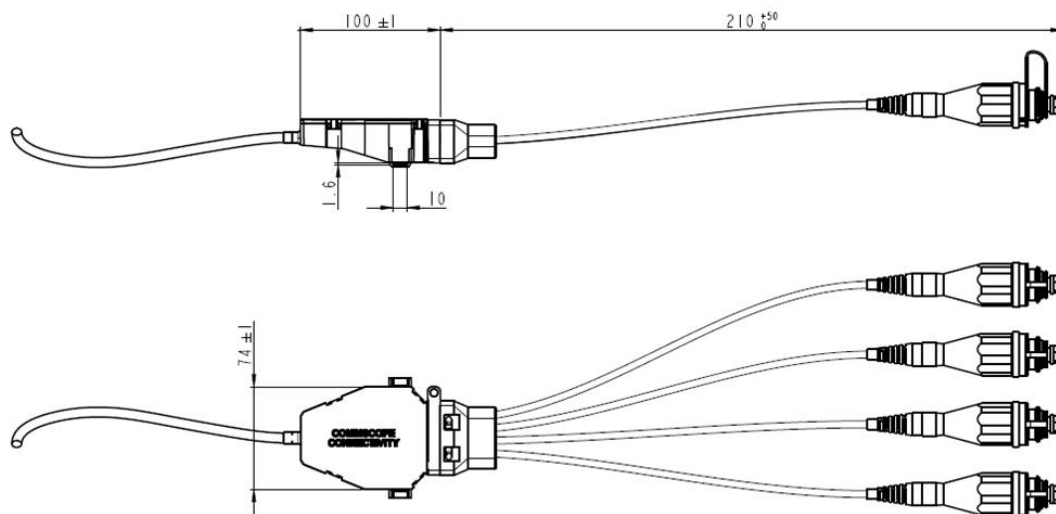

## Mechanical Specifications

<b>Enclosure Material Type</b>	Engineered plastic
<b>Mount Type</b>	Handhole   Pedestal

## Optical Specifications

<b>Fiber Type</b>	G.657.A2
<b>Insertion Loss, Terminal Connector, maximum</b>	0.45 dB
<b>Return Loss, Connector, minimum</b>	60 dB
<b>Wavelength Range</b>	1310–1625 nm

## Environmental Specifications

<b>Environmental Space</b>	Above ground   Below ground   Buried
<b>Operating Temperature</b>	-20 °C to +65 °C (-4 °F to +149 °F)
<b>Qualification Standard</b>	IEC 61753-1 Ed2 category G, IP68, 2 m waterhead
<b>UV Resistance</b>	UV stabilized

## Regulatory Compliance/Certifications

Agency	Classification
RoHS 2011/65/EU	Compliant
ISO 9001:2015	Designed, manufactured and/or distributed under this quality management system

