

AMPINNERGY® Power Entry Cable Assembly, 5-wire/3-circuit (3-1-1), shared neutral, 3 feet

- Used to interface between manufactured wiring and other wiring systems, such as building wiring, fixture wiring, or access floor module wiring
- Mates to line connector cable assemblies, power junction boxes, power distribution modules (PDMs), zone distribution modules (ZDBs) and power transition units (PTUs)

Product Classification

Brand	AMPINNERGY®
Product Series	AMPINNERGY
Product Type	Power entry cable assembly
Regional Availability	North America

Dimensions

Cord Length	0.91 m 3.00 ft
Exposed Conductor Length	12.00 in

Electrical Specifications

Current Rating, maximum	20.00 A
Voltage Rating, maximum	125.00 Vac 250.00 Vac

Environmental Specifications

Environmental Space	Indoor
Safety Standard	CEC 2015 CSA 22.2 NEC 2013 UL 1286 UL 183 UL 498

General Specifications

Application	Line entry connection
Construction Type	Corrugated hose
Interface, connector A	Power male plug
Interface, connector B	Unterminated
Neutral Conductor Gauge, solid	10 AWG
Neutral Type	Shared
Package Quantity	1
Packaging Type	Bag

Mechanical Specifications

Wiring	5-Wire/3 Circuit (3-1-1)
---------------	--------------------------

Outline Drawing

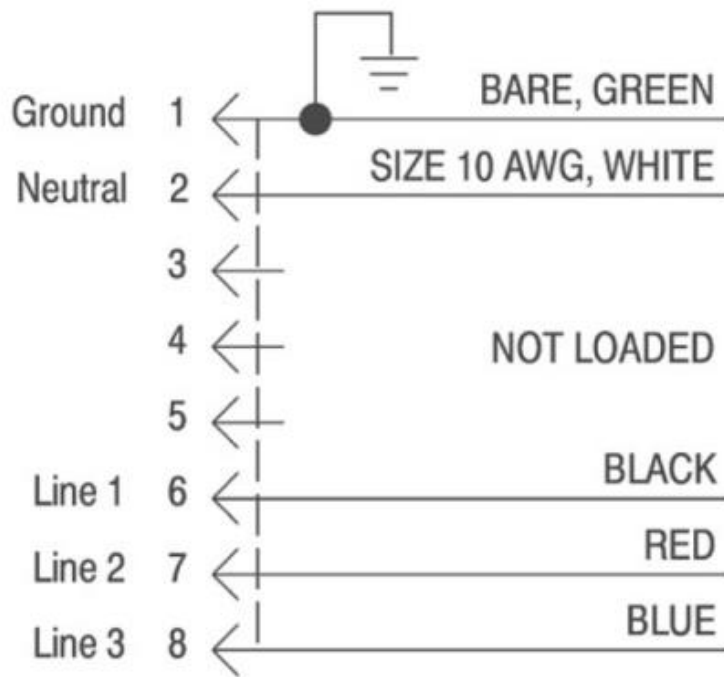

Outline Drawing

Used as an image placeholder

Regulatory Compliance/Certifications

Agency

RoHS 2011/65/EU

Classification

Compliant

