

Installation Instructions

Connector Attachment

For Braided Cable CNT-240
 BNC Male, Solder Pin,
 Crimp-type Body: 240PBM-CR

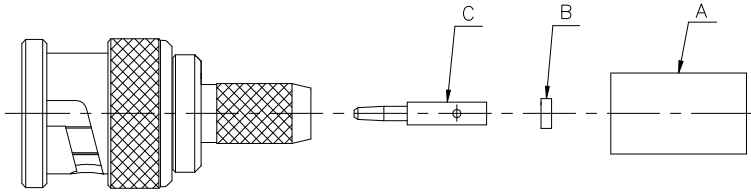

240PBM-CR

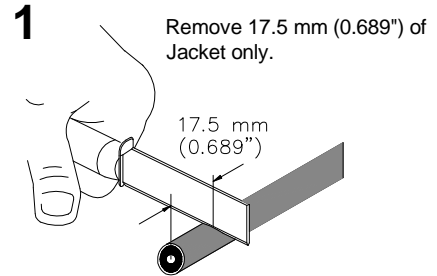

2 Trim 7.0 mm (0.276") of Braid, exposing foam.

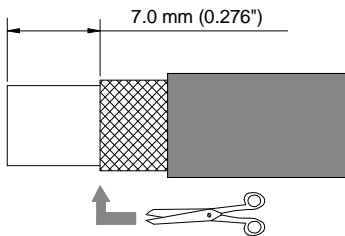

3 Remove 5.0 mm (0.197") of foam, exposing center conductor.

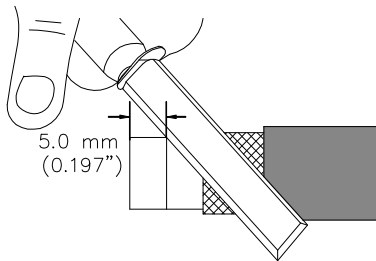

4 Chamfer the center conductor at a 45° angle.

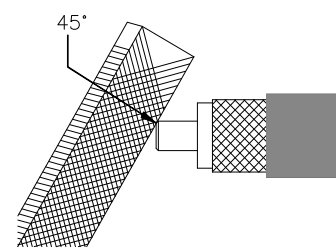

5 Push parts B, C onto the cable center conductor.

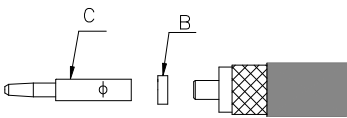

6 Solder part C and cable center conductor together. Inspect soldering point, solder should fill cup but not spill over.

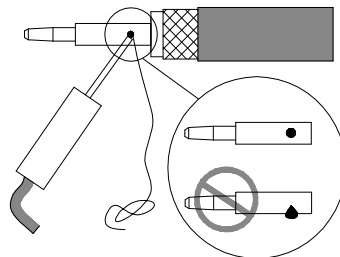

7 Slide part A onto cable, splay out braid as shown.

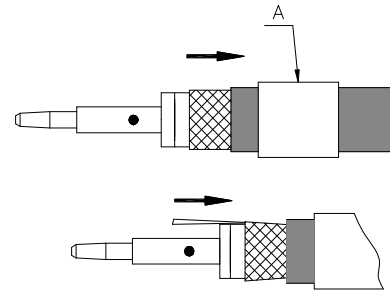

8 The cable attachment must be straight and aligned with the hole of connector insulator. Insert cable attachment into connector body until stopped; the center conductor must be inserted into insulator hole. Make sure the braid cover on body sleeve and push part A onto braid.

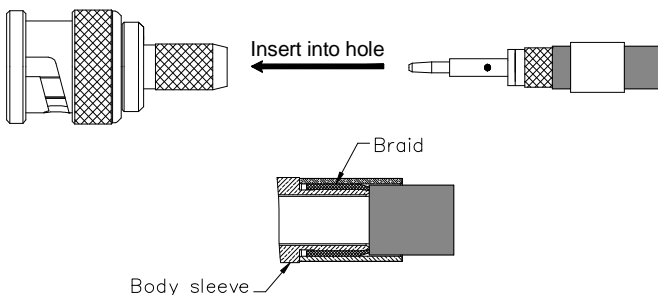

9 Crimp the ferrule at the area as shown. Crimp tool part number is: CTBC-2.

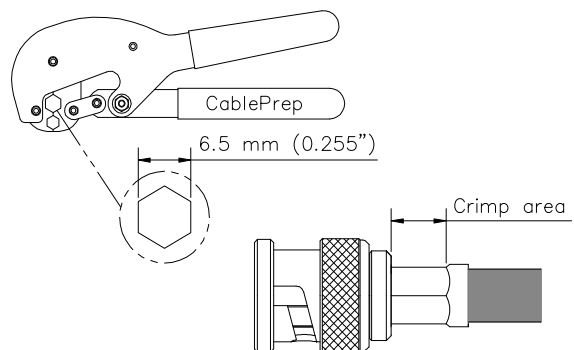

	表一 有毒有害物质或元素名称及含量标识格式					
	有毒有害物质或元素					
部件名称 (Part Name)	铅 (Pb)	汞 (Hg)	镉 (Cd)	六价铬 (Cr6+)	多溴联苯 (PBB)	多溴二苯醚 (PBDE)
连接器 (Connector)	X	O	O	O	O	O

O: 表示有毒有害物质在该部件所有的均质材料中的含量均在SJ/T 11363-2006规定的限量要求以下.
X: 表示该有毒有害物质至少在该部件的某一均质材料中的含量超出SJ/T 11363-2006规定的限量要求.



Installation Training Available at Andrew Institute

Notice: Andrew disclaims any liability or responsibility for the results of improper or unsafe installation, inspection, maintenance, or removal practices

Andrew Corporation

3 Westbrook Corporate Center, Suite 900, Westchester, Illinois U.S.A. 60154
+1 (708) 349-3300 Fax (U.S.A.): 1-800-349-5444
www.andrew.com

Copyright © 2007 by Andrew Corporation

Customer Service, 24 hours

U.S.A., Canada, Mexico: 1-800-255-1479
U.K.: 0800 250055
Other Europe: +44 592 782 612