

Fiber Indoor Cable, LSZH Riser, All-Dielectric, Central Tube Ribbon, Multimode, OM4, bend insensitive, 12 Fibers, Gel-free, Feet jacket marking, Aqua jacket color

## Product Classification

<b>Regional Availability</b>	Asia   Australia/New Zealand   EMEA   Latin America   North America
<b>Portfolio</b>	CommScope®
<b>Product Type</b>	Fiber indoor cable
<b>Product Series</b>	N-CN

## General Specifications

<b>Cable Type</b>	Ribbon central tube
<b>Construction Type</b>	Non-armored
<b>Subunit Type</b>	Gel-free
<b>Fibers per Ribbon, quantity</b>	12
<b>Jacket Color</b>	Aqua
<b>Jacket Marking</b>	Feet
<b>Total Fiber Count</b>	12

## Dimensions

<b>Buffer Tube/Subunit Diameter</b>	6 mm   0.236 in
<b>Diameter Over Jacket</b>	9.4 mm   0.37 in

## Representative Image

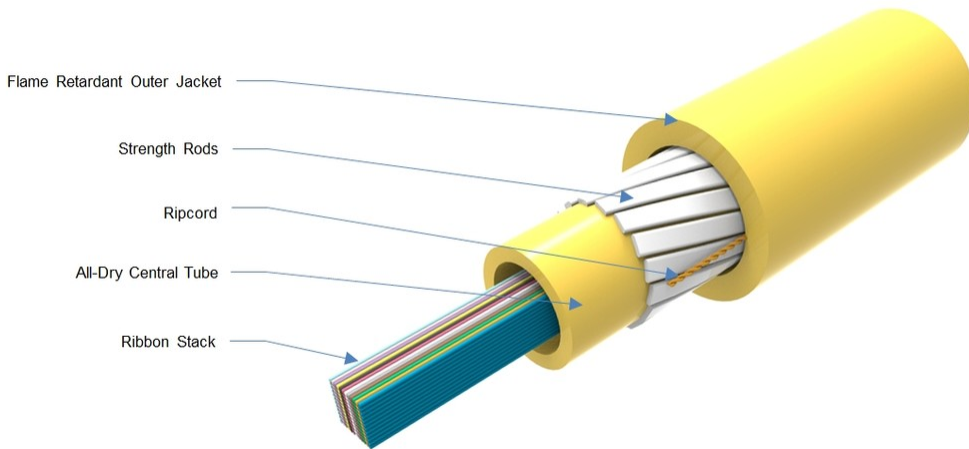

## Mechanical Specifications

<b>Minimum Bend Radius, loaded</b>	188 mm   7.402 in
<b>Minimum Bend Radius, unloaded</b>	94 mm   3.701 in
<b>Tensile Load, long term, maximum</b>	334 N   75.086 lbf
<b>Tensile Load, short term, maximum</b>	1335 N   300.12 lbf
<b>Compression</b>	10 N/mm   57.101 lb/in
<b>Compression Test Method</b>	FOTP-41   IEC 60794-1 E3
<b>Flex</b>	25 cycles
<b>Flex Test Method</b>	FOTP-104   IEC 60794-1 E6
<b>Impact</b>	2.94 N-m   26.021 in lb
<b>Impact Test Method</b>	FOTP-25   IEC 60794-1 E4
<b>Strain</b>	See long and short term tensile loads
<b>Strain Test Method</b>	FOTP-33   IEC 60794-1 E1
<b>Twist</b>	10 cycles
<b>Twist Test Method</b>	FOTP-85   IEC 60794-1 E7

## Optical Specifications

<b>Fiber Type</b>	OM4, bend insensitive   OM4, bend insensitive
-------------------	---

## Environmental Specifications

<b>Installation temperature</b>	0 °C to +70 °C (+32 °F to +158 °F)
<b>Operating Temperature</b>	-20 °C to +70 °C (-4 °F to +158 °F)

# 760212308 | N-012-CN-RB-F12AQ/5X/99E

---

<b>Storage Temperature</b>	-40 °C to +70 °C (-40 °F to +158 °F)
<b>Cable Qualification Standards</b>	ANSI/ICEA S-83-596   Telcordia GR-409
<b>Environmental Space</b>	Low Smoke Zero Halogen (LSZH)   Riser
<b>Flame Test Listing</b>	NEC OFNR-ST1 (UL) and c(UL)
<b>Flame Test Method</b>	IEC 60332-3   IEC 60754-2   IEC 61034-2   UL 1666   UL 1685

## Environmental Test Specifications

<b>Heat Age</b>	-20 °C to +85 °C (-4 °F to +185 °F)
<b>Heat Age Test Method</b>	IEC 60794-1 F9
<b>Low High Bend</b>	-20 °C to +70 °C (-4 °F to +158 °F)
<b>Low High Bend Test Method</b>	FOTP-37   IEC 60794-1 E11
<b>Temperature Cycle</b>	-20 °C to +70 °C (-4 °F to +158 °F)
<b>Temperature Cycle Test Method</b>	FOTP-3   IEC 60794-1 F1

## Packaging and Weights

<b>Cable weight</b>	90 kg/km   60.477 lb/kft
---------------------	--------------------------

## Regulatory Compliance/Certifications

<b>Agency</b>	<b>Classification</b>
ISO 9001:2015	Designed, manufactured and/or distributed under this quality management system

## Included Products

CS-5X-RB	- 50µm OM4 Bend-Insensitive Multimode Fiber
----------	---

## \* Footnotes

**Operating Temperature** Specification applicable to non-terminated bulk fiber cable