

FL1-G177NNN2-1100N



FL1000 Fiber Wall Box, 2-door, singlemode SC/UPC, 12-ports, with pigtailed and splice tray, 1 cable clamp, 1 compression fitting

- Ideal for small to medium fiber counts within communication rooms or closets at customer sites
- Provides demarcation access for the telecom carrier and the end-user by way of separate compartments
- Guarantees mechanical protection and fiber management for indoor and outdoor cable
- Fully customizable for patch-patch, splice-patch or for the storage of un-terminated (dark) fibers

Product Classification

Regional Availability	North America
Product Type	Fiber wall box
Product Series	FL1000

General Specifications

Application	Patching Splicing
Adapter Packs Included, quantity	2
Adapters, quantity	12
Cable Clamps, quantity	1
Cable Compression Fittings, quantity	1
Cable Entry Location	Bottom left Bottom right Top left Top right
Cable Type	Pigtails - Stranded
Color	Putty white
Door, quantity	2
Front Door Type	Single hinged
Growth Configuration	Fully loaded
Interface	SC/UPC
Mounting	Wall
Splicing Type	Heat shrink, mass fusion
Total Fibers, quantity	12
Total Ports, quantity	12

Dimensions

Height	433 mm 17.047 in
---------------	--------------------

FL1-G177NNN2-1100N

Width	511 mm 20.118 in
Depth	156.97 mm 6.18 in

Outline Drawing

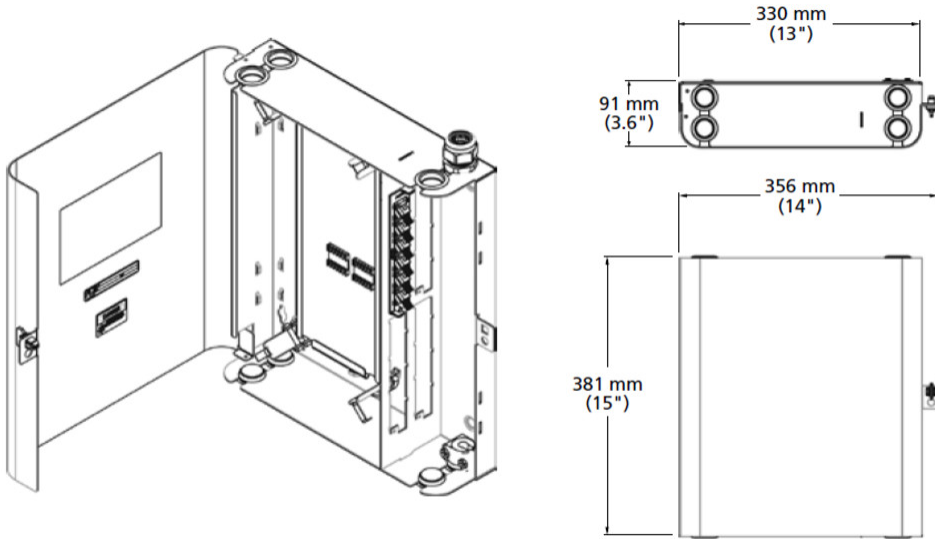

Material Specifications

Finish	Powder coated
Material Type	Steel

Optical Specifications

Fiber Mode	Singlemode
-------------------	------------

Environmental Specifications

Environmental Space	Indoor
Qualification Standards	NEMA type 12

Packaging and Weights

Packaging quantity	1
Packaging Type	Bag Carton

Regulatory Compliance/Certifications

FL1-G177NNN2-1100N

Agency**Classification**

CHINA-ROHS

Above maximum concentration value

REACH-SVHC

Compliant as per SVHC revision on www.commscope.com/ProductCompliance

ROHS

Compliant/Exempted

UK-ROHS

Compliant/Exempted

