

# MHT-06H200U-A0500F

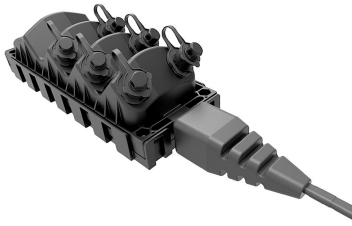

MHT Fiber Optic Multiport Service Terminal, 6-port, HMFOC, dielect. flat loose tube cable, 500 ft

- Hardened connectors are factory-terminated and environmentally sealed for use in optical drop cable deployments
- Plug and play adapter ports ensure rapid cable installment in the outside plant access section of the network
- Multiport Service Terminals incorporate hardened connector technology that is designed to withstand the rugged outside plant environment

## Alternative products available:

HMT-B6M2A0500FN000 NOVUX™ Hardened Mulfi-fiber Terminal, 6 HMFOC ports, 2 fibers per port, Dielectric flat loose tube cable with HMFOC plug (female/no pin), 500 ft/152 m

## Product Classification

<b>Regional Availability</b>	Latin America   North America
<b>Product Type</b>	Access terminal, without splitter/tap
<b>Product Series</b>	MHT

## General Specifications

<b>Cable Type</b>	Dielectric - Flat - Loose Tube
<b>Cable, quantity</b>	1
<b>Distribution Type</b>	6 ports
<b>Enclosure Color</b>	Black
<b>Mounting</b>	Handhole   Pedestal   Pole   Strand
<b>Port Type</b>	Hardened multi-fiber (HMFOC) jack, male/pinned
<b>Port, quantity</b>	6
<b>Splitter, quantity</b>	0
<b>Stub Type</b>	Stub tail

## Dimensions

<b>Height</b>	298 mm   11.732 in
<b>Width</b>	130.3 mm   5.13 in
<b>Depth</b>	89 mm   3.504 in

# MHT-06H200U-A0500F

<b>Cable Length, stub</b>	500 ft (152 m)
<b>Cable Outer Diameter</b>	4.5 x 8.1 mm (0.18 x 0.32 in)

## Dimension Drawing

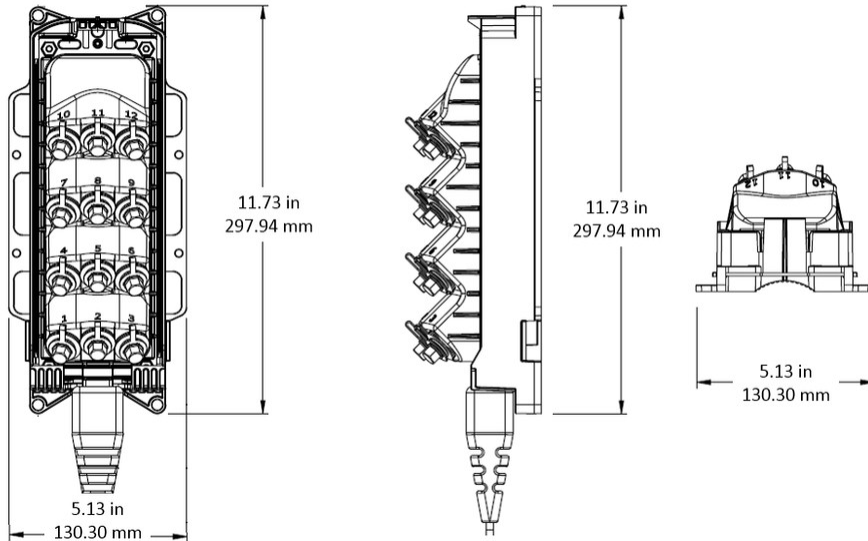

## Ordering Tree

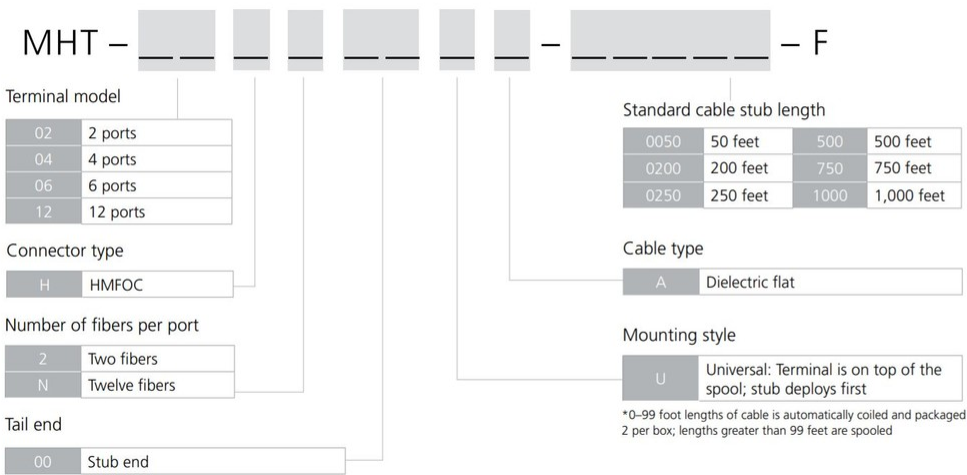

## Material Specifications

<b>Enclosure Material Type</b>	Gasketed hardened plastic
--------------------------------	---------------------------

## Optical Specifications

# MHT-06H200U-A0500F

<b>Fiber Type</b>	G.657.A1/A2
<b>Operating Wavelength Range</b>	1260 – 1635 nm
<b>Attenuation Cable Coefficient, maximum</b>	0.30 dB/km @ 1550 nm   0.40 dB/km @ 1310 nm
<b>Attenuation Terminal Connectors, maximum</b>	0.45 dB
<b>Directivity, minimum</b>	60 dB
<b>Insertion Loss, Terminal Connector, typical</b>	0.16 dB
<b>Return Loss, Connector, minimum</b>	65 dB

## Environmental Specifications

<b>Operating Temperature</b>	-40 °C to +70 °C (-40 °F to +158 °F)
<b>Relative Humidity</b>	5%–100%, condensing
<b>Environmental Space</b>	Above ground   Below ground   Buried
<b>Flammability Rating</b>	UL 94 V-0
<b>Qualification Standards</b>	IEC 60529, IP68 + 2 m waterhead   Telcordia GR-3120-CORE   Telcordia GR-326-CORE   Telcordia GR-771-CORE
<b>UV Resistance</b>	UV stabilized

## Packaging and Weights

<b>Included</b>	Enclosure (1)   Universal mounting bracket (1)
<b>Packaging quantity</b>	1
<b>Packaging Type</b>	Box   Carton
<b>Weight, without cable</b>	0.99 kg   2.183 lb

## Regulatory Compliance/Certifications

<b>Agency</b>	<b>Classification</b>
CHINA-ROHS	Above maximum concentration value
ISO 9001:2015	Designed, manufactured and/or distributed under this quality management system
REACH-SVHC	Compliant as per SVHC revision on <a href="http://www.commscope.com/ProductCompliance">www.commscope.com/ProductCompliance</a>
ROHS	Compliant/Exempted
UK-ROHS	Compliant



## Included Products

# MHT-06H200U-A0500F

---

MST-UMB-MINI – DLX® Mini-MST, Fiber Optic Universal Mounting Bracket