

# TH1572-000 | FOSC450-BS-6-24-1-BOV-ETB72



FOSC® 450 BS Fiber Optic Splice Closure, Gel Cable sealing, one pre-installed 24-splice tray, 6 cable attachments, with test valve

- Single-ended, O-ring sealed dome closure for splicing feeder and distribution cables
- Gel cable sealing technology allows easy adding or removing of a wide size range of cables
- Compatible with most common cable types: e.g. loose tube, central core, ribbon fiber
- FOSC splice trays hinged for access to any splice without disturbing other trays
- Closure can be used in aerial, pedestal and underground (up to 5 meters) environments
- Compatible with CommScope's CWDM modules and optical splitter trays

## Product Classification

<b>Regional Availability</b>	Latin America   North America
<b>Product Type</b>	Single-ended, round fiber closure
<b>Product Brand</b>	FOSC®
<b>Product Series</b>	FOSC 450

## General Specifications

<b>Cable Entry Drop Port Style</b>	Round
<b>Cable Entry Main Port Style</b>	Round
<b>Cable Ports Quantity, total</b>	6 round ports
<b>Cable Sealing Type</b>	Compressed gel
<b>Closure Sealing Type</b>	Dome-to-base clamp with O-ring
<b>Closure Style</b>	Single-ended
<b>Color</b>	Black
<b>Fiber Storage Basket Type</b>	B6, BS standard size
<b>Mounting</b>	Pole   Strand   Wall
<b>Network Area Type</b>	Feeder
<b>Splice Tray Included, quantity</b>	1
<b>Splice Tray Type Included</b>	24-way, heat shrink
<b>Splicing Capacity, Mass Fusion, maximum</b>	144
<b>Splicing Capacity, Single Fusion, maximum</b>	144
<b>Splicing Capacity, Single Splice, 12 fibers, maximum</b>	144
<b>Splicing Capacity, Single Splice, 6 fibers, maximum</b>	72

# TH1572-000 | FOSC450-BS-6-24-1-BOV-ETB72

**Splicing Type, Supported**

Mass fusion | Single fusion

## Dimensions

**Length**

490 mm | 19.291 in

**Diameter**

180 mm | 7.087 in

**Diameter, with clamp**

232 mm | 9.134 in

**Main Cable Diameter, maximum**

25 mm | 0.984 in

## Dimension Drawing

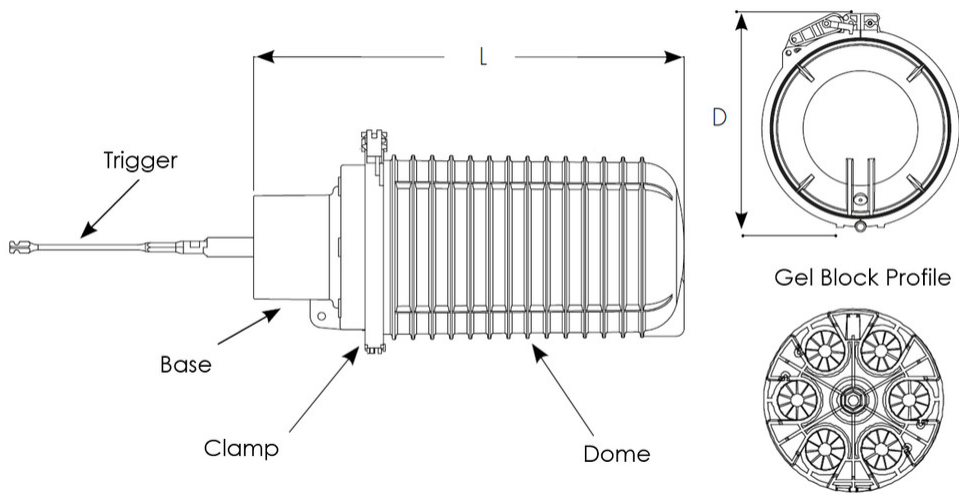

## Ordering Tree

# TH1572-000 | FOSC450-BS-6-24-1-BOV-ETB72

## FOSC 450 - XX - X - XX - X - X X X

### Closure Size (inches)

A4	4 cable entry ports; 8 dia. x 19 long
BS	6 cable entry ports; 9 dia. x 19.5 long
B6	6 cable entry ports; 10 dia. x 24 long
C6	6 cable entry ports; 11.5 dia. x 23 long
D6	6 cable entry ports; 11.5 dia. x 30 long

### Termination Hardware Quantity for the Kit

2	2 cable attachments included
4	4 cable attachments included
6	6 cable attachments included (N/A for A size)

### Capacity and Type of Splice Tray

NT	No tray installed in factory
12	A, B, or C tray with two SM6 splice modules
24*	A, B, or C tray with two SM12 splice modules
36	D tray with six SM6 splice modules
72*	D tray with six SM12 splice modules
R1	A, B size ribbon tray (accommodates 12 ribbons/144 fibers)
R2	D size ribbon tray (24 ribbons/288 fibers)
R3	C size ribbon tray (18 ribbons/216 fibers)
SF	Stackable single fusion trays (12 splices)

\*Note: SMOUV (1120-01) splice protection sleeves are highly recommended for use with SM12 splice modules.

### Quantity of Splice Trays Factory Installed

0 or 1 is standard	Choose either "0" trays (no trays installed) or "1" tray installed. Additional trays sold separately.
--------------------	---

### Valve for Flash Testing

V	Valve (standard)
N	No Valve

Note: We recommend flash test valves for FOSC closures. However, non-valved closures are available upon request.

### Number of Ground Feed-through Lugs

0	No grounding
1	1 ground feed-through lug (A4 only, N/A for BS)
3	3 ground feed-through lugs (B6, C6, and D6 closures only, N/A for BS)
6	6 ground feed-through lugs (C6 and D6 closure only, N/A for BS)

Note: FEG and MEG kits provide optional ground isolation for FOSC 450 closures.

### Slack Basket Type

N	No Basket
A	A4 Standard Size
B	B6, BS Standard Size
C	C6 Standard Size
D	D6 Standard Size
E	Special Bulkhead Basket arrangement for B, BS closures only
T	Tall Size
S	Stackable Trays in D Closure

Note: D-size closures with "N" option include backbone used to route ribbons to ribbon trays. A and B-size closures include storage "socks".

## Material Specifications

### Material Type

Impact-resistant polymer

## Environmental Specifications

### Environmental Space

Below ground | Buried

### Qualification Standards

IEC 61300, 5 m waterhead

### Water Resistance

Flash test valve at 5 psi (40 kPa)

## Packaging and Weights

### Packaging quantity

1

### Packaging Type

Box | Carton

### Weight, net

4.54 kg | 10.009 lb

## Regulatory Compliance/Certifications

**Agency****Classification**

CHINA-ROHS

Above maximum concentration value

ISO 9001:2015

Designed, manufactured and/or distributed under this quality management system

REACH-SVHC

Compliant as per SVHC revision on [www.commscope.com/ProductCompliance](http://www.commscope.com/ProductCompliance)

ROHS

Compliant/Exempted

