

LSA-PLUS® Series 2

A technically and commercially superior quick connection system for all state-of-the-art networks. Contacts that ensure the highest degree of reliability even under the most adverse environmental and climatic conditions. A completely reliable, gas-tight connection between the contact and conductor. That's LSA-PLUS® technology.

CommScope's LSA-PLUS System family consists of a comprehensive and diverse range of high density, standard and special modules, mounting hardware, test and patch cords, accessories and protection devices.

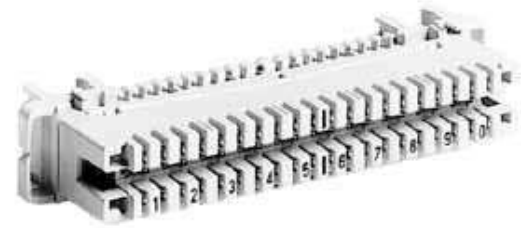

Voice, high-speed data transmission via xDSL cable TV, Internet access, mobile networks: working in conjunction with CommScope you will be able to confidently face the issues created by vast amounts of network traffic. In addition, CommScope quality ensures total end-customer satisfaction. CommScope copper connectivity solutions are designed to deliver fast, safe and reliable transmission.

Features and benefits

- Eight- and ten-pair modules with disconnection points for opening the line, testing in both directions or insertion of graded protection elements
- Based on genuine LSA-PLUS connection technology
- Available in eight- and ten-pair configurations with parallel test access or overvoltage protection contact
- LSA-PLUS modules mount on back mount frames
- LSA PROFIL modules mount on profile rods (8-pair modules: 75 mm spacing between rods; 10-pair modules: 95 mm spacing between rods) or on back mount frames
- Suitable for use in all xDSL circuits
- Robust long-term environmental stability allows both indoor and outdoor installation
- Supports all LSA-PLUS Series 2 accessories
 - Overvoltage protection magazine and single pair ComProtect designs.
 - Labelling such as number flags, label holders and others
 - Test and connection cords

Specifications

Design and configuration

Disconnection modules (system color: white)

Compared to the connection modules, the LSA-PLUS disconnection modules feature additional functions, because the circuit can be disconnected using plugs or cords when required. This feature provides a wide range of possibilities, for example the implementation of an “intelligent” protection systems, measuring and testing in two directions, connecting via cords or “looping in” of functional elements (e.g. attenuation plugs).

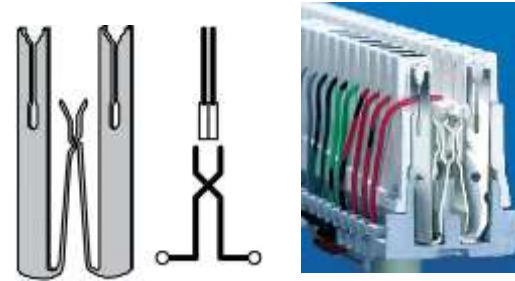

Connection modules (system color: grey)

The wires are connected to the opposite contacts at the system/cable and at the jumper sides. Separate access contacts are located at the center of each pair; e.g. for monitoring, measuring and testing work, for switching using switching adapters or for connecting overvoltage protection magazines (3-point protection with overvoltage arresters or semiconductor components).

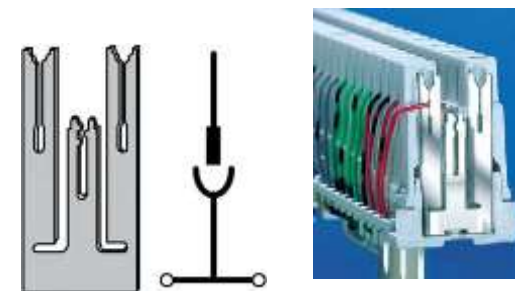

Switching modules (system color: brown)

The individual contacts and hence the circuits of the LSA-PLUS switching module are disconnected when idle. By inserting plugs or cords, the circuits can be connected when necessary. It is also possible to install 5-point or graded protection.



Earthing module (system color: red)

Depending on the version, the LSA-PLUS earth modules (connection contacts) permit the routing of up to 36 cable wires to one common electrical potential. Via a permanently connected, flexible earth line, the back-mount frame or an earth terminal is connected to earth potential.

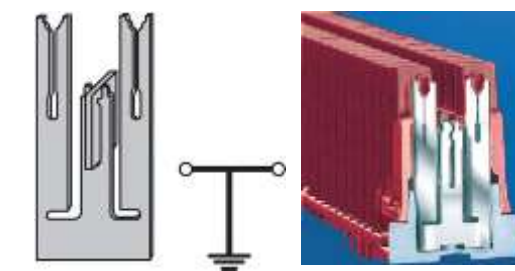

Available configurations

	Disconnection modules	Connection modules	Switching modules	Earthing module
10-pair profile rod	Available	Available	Available	Available
10-pair back mount frame	Available	Available	Available	Available
8-pair profile rod	Available	Available	NA	NA
8-pair back mount frame	Available	NA	NA	NA

General attributes & mechanical characteristics

8-pair modules:

Description	Order No.
LSA-PLUS Series 2 disconnection module, no color code. Printed: jumper side 1...8	60361102-00
LSA PROFIL Series 2 connection module, no color code. Printed: jumper side 1...8	60361004-00
LSA PROFIL Series 2 disconnection module. <i>For profile rod installations with 75 mm spacing between rods.</i> No color code. Printed: jumper side 1...8 (universal for BMF and Profile mounting)	60361005-00
LSA PROFIL Series 2 disconnection module. <i>For profile rod installations with 95 mm spacing between rods.</i> No color code. With jumper guides. Printed: jumper side 1...8	60891128-01

10-pair modules:

Description	Order No.
LSA-PLUS Series 2 connection module	
Cable end up, no color code. Printed: jumper side 1...0	60891002-02
Cable end up, with color code type 1. Printed: jumper side 1...0	60891002-01
Cable end up, no color code. Printed: jumper side 0...9	60891002-06
LSA-PLUS Series 2 disconnection module	
No color code. Printed: jumper side 1...0	60891102-02
With color code type 1. Printed: jumper side 1...0	60891102-01
No color code. Printed: jumper side 0...9	60891102-06
With color code type 3. Printed: jumper side 1...0	60891102-09
LSA-PLUS Series 2 switching module. Printed: jumper side 1...0	60892089-00
LSA-PLUS Series 2 Earthing module, ground wire strip 2/38 with earth wire & ring cable lug for M4.	60892017-00
LSA PROFIL Series 2 connection module (universal for BMF and Profile mounting)	
No color code. Printed: jumper side 1...0	60891120-02
With color code type 1. Printed: jumper side 1...0	60891120-01
No color code. With large jumper guides. Printed: jumper side 1...0	60891120-19
LSA PROFIL Series 2 disconnection module (universal for BMF and Profile mounting)	
No color code. Printed: jumper side 1...0	60891121-02
With color code type 1. Printed: jumper side 1...0	60891121-01
No color code. With large jumper guides. Printed: jumper side 1...0	60891121-17

LSA PROFIL Series 2 switching module. Printed: jumper side 1...0 (universal for BMF and Profile mounting)	60891126-00
LSA PROFIL Series 2 Earthing module (universal for BMF and Profile mounting)	
Ground wire strip 2/34 <i>For profile rod installations with 95 mm spacing between rods.</i>	60892108-01
Ground wire strip 2/34 without jumper wire guide. <i>For profile rod installations with 95 mm spacing between rods.</i>	60892108-00
Ground wire strip 2/26 without jumper wire guide. <i>For profile rod installations with 75 mm spacing between rods.</i>	60362121-00

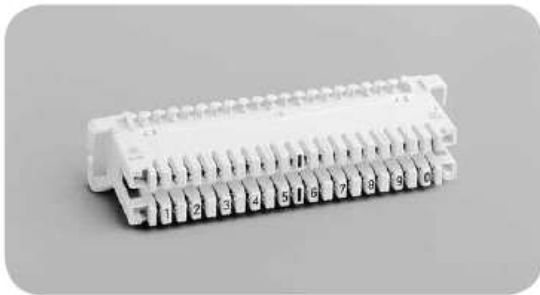

LSA-PLUS Series BACK MOUNT FRAME module

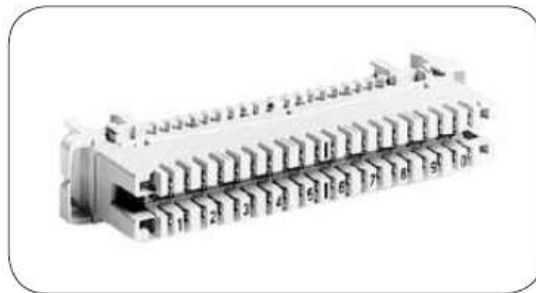

LSA PROFILE Series module

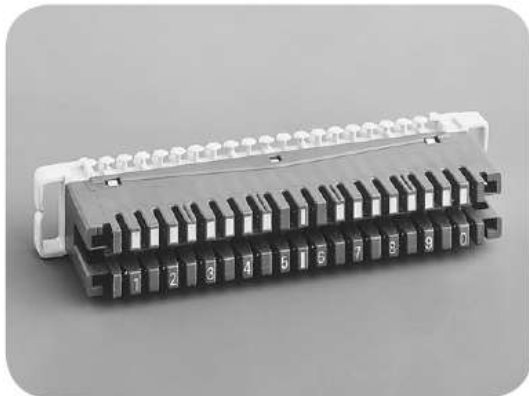

LSA-PLUS Series 2 switching module 10-pair



LSA-PLUS Series 2 Earthing module 2/38

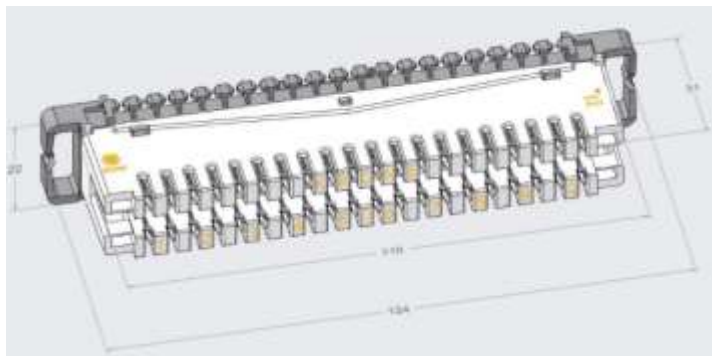

LSA-PLUS Series 2 module 10-pair, basic dimensions in mm.

Colour code 1:

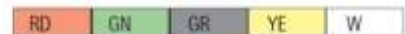

Colour code 2:



Colour code 3:



Printing color code types

LSA-PLUS® Disconnection module for shielded cables

The expansion of mobile communications networks, including mobile phone systems and the steady growth of IP networks, have created a demand for bandwidth in both access and transmission networks. This in turn causes the extension of existing hubs and the installation of new hubs.

Features & benefits

- Disconnection module for the distribution of eight shielded pairs
- Applications include:
 - Internet backbone
 - GSM networks
- Complies with ITU-T G.703 recommendations (physical/electrical characteristics of hierarchical digital interfaces)
- Category 6-rated NEXT performance
- Compatible with a wide-range of LSA-PLUS®
- Series 2 accessories
- Accessories disconnect only the Line A/Line B contacts, while the shielding remains interconnected. Plugs and cords are available to disconnect the shield, should that be required
- Ports are marked on the module

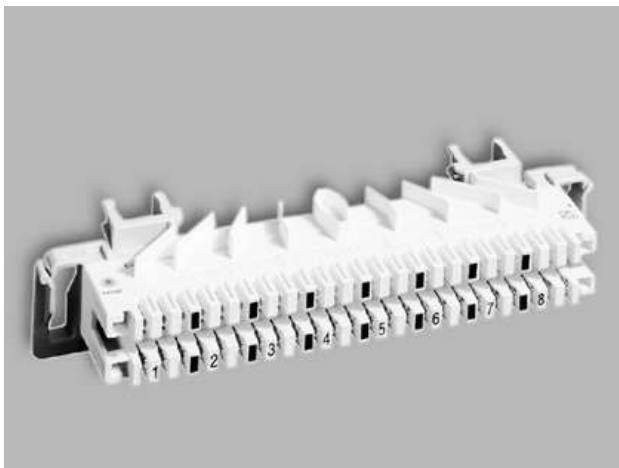

LSA PROFIL Series 2 8-pair disconnection module

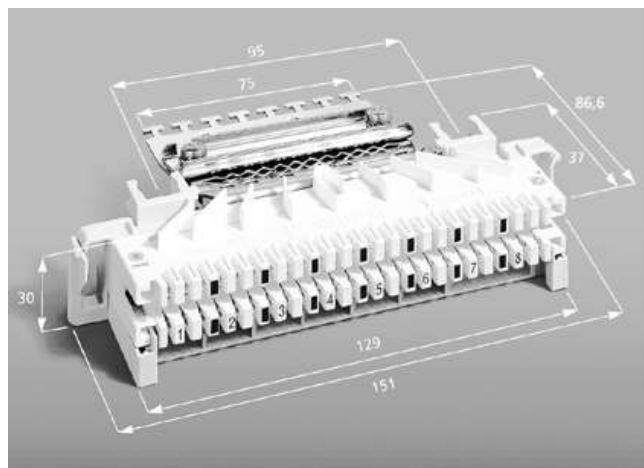

LSA PROFIL Series 2 8-pair module x abs with accessories

Ordering information

Description	Order No.
LSA PROFIL Series 2 8-pair disconnection module for shielded twisted pair (abs)	
With left and right jumper guides	70151008-01
With 3 wire guides for jumpers to the left	70151004-50
With 3 wire guides for jumpers to the right	70151005-50
Accessories	
Hinged label holder	70151003-50
Cable support with cable mounting and shield contact for 1 cable with 8 pairs Depth: 12 mm	70151009-01
Universal cable support for 1-, 2- and 4-pair cables. Depth: 3–6 mm	70151009-21

LSA-PLUS® Series 2 Disconnection Module 2/10 to Screw Terminal

KRONE LSA-PLUS® Disconnection Module 2/10 to Screw terminal has 20 position screw terminals soldered to a PCB. Each IDC contact of the module is connected to the relevant contact of 20 position screw terminal through PCB, thus permitting wires up to 2.5 Sq. mm to be connected to the module.

The assemblies can be supplied as single unit with 20 position terminals on one side or as double units with 20 position terminals connected to both row of IDC contacts

Features & benefits

- Can be used as drop wire module in military field installations/rural telecom network
- Occupies 2 or 3 ways of BMF
- Supports all LSA-PLUS® S2 accessories
- Flexible indoor and outdoor use
- Robust long term environmental stability
- Overvoltage/Overcurrent protection

Specifications

- Screw terminal:
 - Conductor cross section up to 2.5 Sq. mm
 - Wire stripping 6 mm
 - Test voltage Up to 2.5 kV
 - Cover Polyamide(Nylon)

Description	Order No.
LSA-PLUS® Series 2 disconnection module 2/10 with additional screw terminals on the jumper side, 20-pole, with a width of 36 mm. Occupies 2 ways of BMF.	70042001-01
LSA-PLUS® Series 2 disconnection module 2/10 with additional screw terminals on both sides, 2 X 20 poles with a width of 48 mm. Occupies 3 ways of BMF.	70042002-01



Disconnection Module 2/10 to Screw Terminal

LSA-PLUS® Series 2 Instrumentation Disconnection Module 2/10

KRONE LSA-PLUS® Disconnection Module 2/10 for terminating large diameter wires.

Features & benefits

- Allows large diameter wires termination
- Supports all LSA-PLUS® S2 accessories
- For mounting on Profil or backmount frames, or 35mm Din rail (using adaptors)
- Flexible indoor and outdoor use
- Robust long term environmental stability
- Overvoltage/Overcurrent protection

Specifications

- Mechanical:
 - Insulation diameter: 1.65 – 1.90 mm
 - Copper conductor diameter: 0.65 – 0.90 mm
 - Multistrand Conductor: 7x0.2 – 7x0.32 mm
- Electrical:
 - Insulation resistance: $\geq 50 \text{ G}\Omega$
 - Test voltage: Up to 2.5 kV
 - Dielectric strength: $\geq 2000 \text{ VAC}$
 - Current rating of LSA-PLUS® contact: = Current carrying capacity of terminated conductor
 - Contact resistance:
 - $\leq 1 \text{ m}\Omega$ typical
 - $\leq 2.5 \text{ m}\Omega$ guaranteed
 - Total contact resistance: $\leq 10 \text{ m}\Omega$
 - Number of re-terminations: ≥ 200
 - Coupling capacitance between wires: $\leq 1 \text{ pF}$

Description	Order No.
LSA-PLUS® Series 2 Instrumentation disconnection module 2/10	64685049-10



Instrumentation Disconnection Module 2/10

Accessories – Back Mount Frames

Selection criteria

Calculating necessary installation space: Back mount frame length = Module spacing x (number of modules – 1) + 20 mm

Frame depth: based on conductor diameter of 0.5 mm, including insulation of 1.5 mm. Deeper frames must be selected for wires measuring 0.6 mm – 0.9 mm, or when the cable is fed through the frame bundle by bundle.

- Up to 70 pairs: >12 mm
- Up to 100 pairs: >22 mm
- Up to 200 pairs: >30 mm
- 200 pairs or greater: >50 mm

Module spacing

- 25 mm with jumper guides on one side
- 22.5 mm with jumper guides on two sides
- 27.5 mm with jumper guides on one side, when wire with thicker insulation is used

Hole pattern

- Hole pattern 1: Central cable entry. Used with mounting adapters for wall mounting or for installation in customer premises connection boxes
- Hole pattern 2: Right-side cable entry, for universal use with asymmetrical mounting

Back Mount Frames with 22.5 mm and 25.0 mm Module Spacing

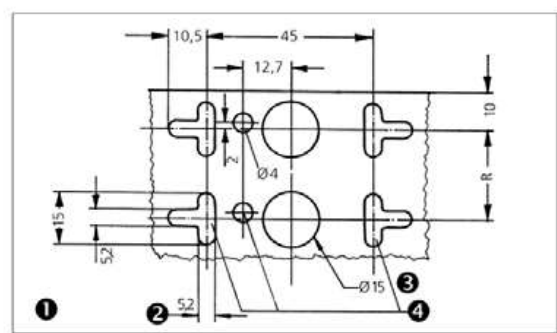
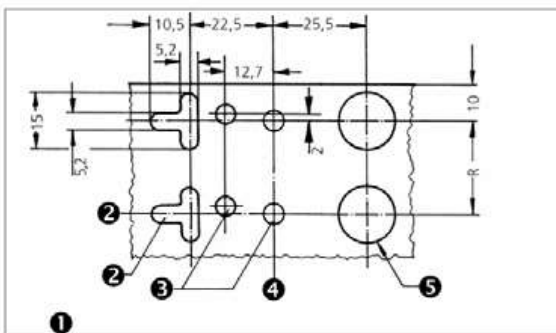
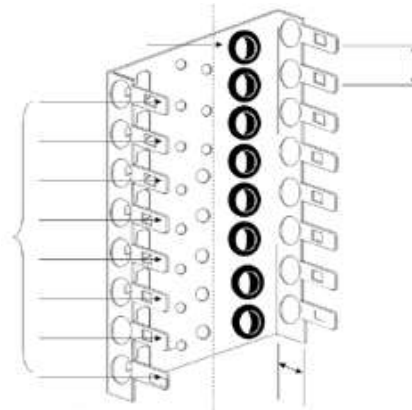

Description	Module spacing	Number of Modules	Order No.	Jumper side
LSA-PLUS Series 2, 10-pair, Depth of cable space/frame: 22.5 mm Hole pattern: 1	12 mm	1, 3, 5, 10	60503112-	01, 03, 05, 10
	22 mm	1, 3, 5, 10, 20	60503122-	01, 03, 05, 10, 20
	30 mm	5, 10, 15, 20	60503130-	05, 10, 15, 20
	50 mm	10, 15, 25, 30, 40, 50	60503150-	10, 15, 25, 30, 40, 50
LSA-PLUS Series 2, 10 pair, Depth of cable space/frame: 25 mm Hole pattern: 2	30 mm	5, 10	64423230-	05, 10
	50 mm	11, 21	64423250-	11, 21
	70 mm	11, 24, 40	64423270-	11, 24, 40
LSA-PLUS Series 2, 8-pair, Depth of cable space/frame: 22.5 mm Hole pattern: 1	22 mm	10	60543122-10	
LSA-PLUS Series 2, 8-pair, Depth of cable space/frame: 25 mm Hole pattern: 2	22 mm	17	64413222-17	
	30 mm	9	64413230-09	

Back Mount Frame

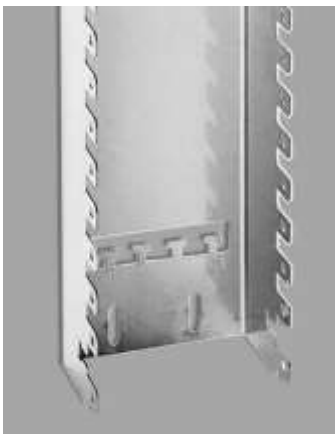

Features and benefits

- Accommodates from 10 to 40 Series 2, 10-pair modules, plus an additional termination module, label holder or earth-wire module
- Blocks of 100 pairs separated from each other (spacing between groups of 10 modules is 30 mm)
- Overall width: 104.5 mm
- Module spacing: 22.5 mm

Number of Modules	Depth of Cable Space	Module Spacing	Dimensions (Length x Width)	Order No.
10 Series 2, 10 -pair modules, plus 1 additional module or label holder	50 mm	22.5 mm	263 mm x 104.5 mm	52673585-00
20 Series 2, 10 -pair modules, plus 1 additional module or label holder	50 mm	22.5 mm	496 mm x 104.5 mm	52673585-01
30 Series 2, 10 -pair modules, plus 1 additional module or label holder	50 mm	22.5 mm	728 mm x 104.5 mm	52673585-02
40 Series 2, 10 -pair modules, plus 1 additional module or label holder	50 mm	22.5 mm	961 mm x 104.5 mm	52673585-03

Back Mount Frame for Cable Head Installations



Features and benefits

- For installations with limited or narrow space
- Two sizes, accommodating five or ten LSA-PLUS® Series 2, 10-pair modules plus an additional termination module, label holder or earth-wire module
- No mounting materials (screws, nuts, washers) are included

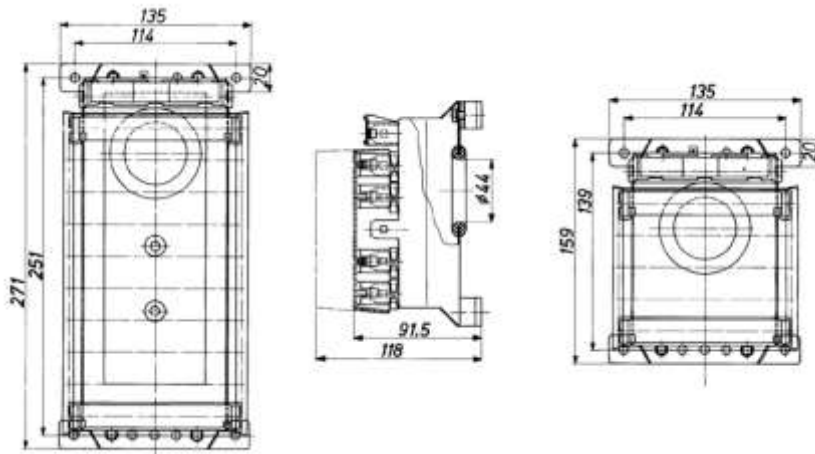

Description	Order No.
Back mount frame for Series 2, 10-pair modules, plus 1 additional module or label holder Size 1, total of 11 mounting spaces	60922024-01

Dust Cover

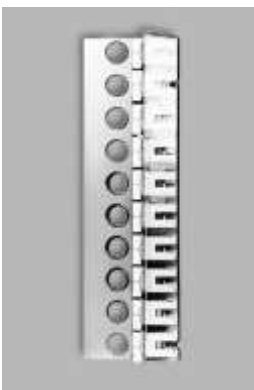

Features and benefits

- Transparent cover protects LSA-PLUS® Series 2, 10-pair modules from dust and accidental disturbance of terminated cable
- The deeper version allows installation of overvoltage protection magazine

Description	Order No.
Shallow dust cover	
100 pairs	60923016-00
50 pairs	60923016-01
Deep dust cover. Allows installation of overvoltage protection magazine	
100 pairs	60923034-10
50 pairs	60923034-11

Mounting Accessories for Back-Mount Frames



60922017-00 Cable clamp kit



60503044-00 Cable protection rings

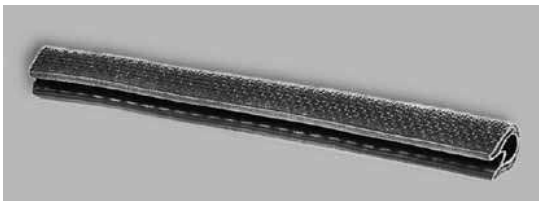

60923017-xx Edge protection strip

Description	Order No.
Cable clamp kit for Series 2 cable head back mount frame Includes 4 clamps, 1 sheath contact screws, 1 clip	60922017-00
Edge protection strip. Placed over unused positions in back mount frame	
120 mm	60923017-00
60 mm	60923017-01
Cable protection rings for 15 mm diameter cables. Mount on rear of back-mount frame to protect cable insulation	60503044-00

Profile Rod Frames



Features and benefits

- Profile frame consists of 2 stainless steel profile rods, each 12 mm in diameter and profile holders 46 mm in depth
- Profile rod frame with 95 mm distance between rods accommodates:
 - Series 2, 10-pair LSA PROFIL modules
 - Series 2, 8-pair LSA PROFIL modules
 - NT, 10-pair LSA PROFIL modules
 - HighBand® modules
 - HD 180 modules
- Profile rod frame with 75 mm distance between rods accommodates:
 - Series 2, 8-pair LSA PROFIL modules
 - NT, 8-pair LSA PROFIL modules
 - Series 10 LSA PROFIL modules

Description	HD 180	Series 2	Length of rods (mm)	Number of profile rod holders included	Order No.
Profile rod frame with 95 mm distance between rods. Number of modules accommodated	20	12	299	2	65772812-01
	40	24	574	2	65772812-02
	60	36	861	3	65772812-03
	80	48	1136	3	65772812-04
	100	60	1423	4	65772812-05
	120	72	1698	4	65772812-06

Individual Profile Rods and Rod Holders



Features and benefits

- Individual rods and rod holders may be ordered to construct a custom, modular frame
- Rod holders with a depth of 86 mm are available: deeper profile frames are used when cable support elements and cable guides are used
- All profile holders accept 12 mm diameter profile rods
- One profile holder should be placed for each 500 mm of profile rod

Description	Number of profile rod holders included	Order No.
Profile rod holder		
Installation depth: 46 mm		
Rod distance: 95 mm		65772834-00
Rod distance: 75 mm		65772834-01
Installation depth: 86 mm		
Rod distance: 95 mm		65772860-00
Installation depth: 190 mm		
Installation depth: 140 mm		
Rod distance: 95 mm		65772868-00
Profile rod		
Diameter: 12 mm steel, unthreaded ends		
Maximum number of Series 2 modules		
12	299	65773835-01
18	447	65773835-25
24	574	65773835-02
33	750	65773835-16
48	1136	65773835-04
55	1260	65773835-08
60	1423	65773835-05
72	1698	65773835-06
76	1800	65773835-07
88	2000	65773835-14
100	2450	65773835-21

Profile Rod Installation Accessories



60362121-00 Jumper guide



66192026-00 Earthing clamp



66192023-00/66192030-00/66192018-00



60893202-00 Earthing contact clip



66192046-xx Spacer



64612013-00 DIN Rail adapter

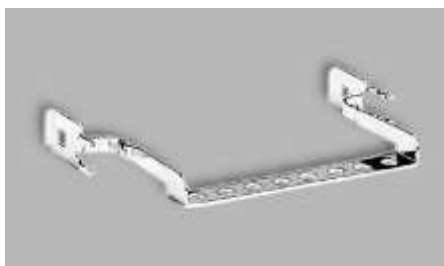

66192040-00 Cable support bracket

Description	Dimensions (H x W x D)	Order No.
Jumper hooks Snap onto bar bracket Distance between hooks: 120 mm Quantity: 4	Depth: 93 mm	66192031-00
Jumper guide Snaps onto profile rod Recommended spacing between frames: >60 mm S-Quantity: 2	10 mm x 45 mm	66192016-00
End unit Snaps on to top or bottom of profile rod installation of 10-pair modules. Also allows installation of a dust cover (requires 2 end units)		
63 mm deep, with spring clip Recommended for use with dust cover Quantity: 2		66192023-00
41 mm deep, with spring clip Recommended for use with dust cover Quantity: 2		66192030-00
41 mm deep, without spring clip Quantity: 1		66192018-00
Spacer Used to create uniform spacing in profile rod installations		
	Height: 2.5 mm	66192046-00
	Height: 5 mm	66192046-01
Cable support bracket For Series 2, 10-pair profile rod installations with distance between rods of 95 mm		
With tabs for overvoltage protection	Depth: 35 mm	66192040-00
Earthing clamp For wire diameters up to 5 mm Mounts on profile rods. Includes screw and assembly instructions Quantity: 1		66192026-00

<p>Earthing contact clip Provides surge-current-proof earth connection between LSAS PROFIL distribution frames and overvoltage protection components. 2 clips required for each LSA PROFIL module Quantity: 20</p>		60893202-00
<p>DIN Rail adapter used to secure 35 mm high LSA PROFIL modules onto DIN rails (DIN 50022)</p>		64612013-00

Label Holder Module

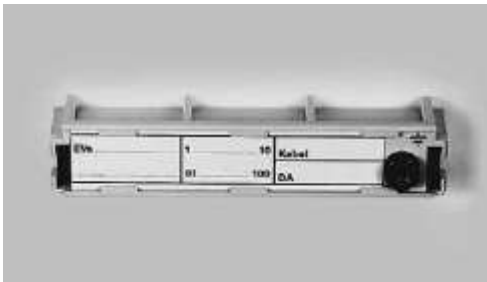

Label holder module for back mount frames

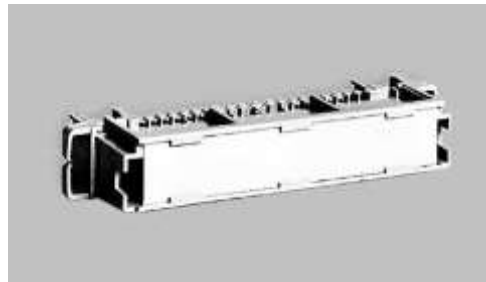

PROFIL-mount label holder

Description	Dimensions (H x W x D)	Order No.
<p>Label holder module for back mount frames Used for row identification Mounts in first or last position of back mount frame. Occupies space of one Series 2, 8- or 10-pair connection module Quantity: 1</p>		
8-pair module	75 mm x 13.2 mm	60362018-00
10-pair modules		
Printed	95 mm x 17.9 mm	60922012-00
Blank	95 mm x 17.9 mm	60922012-02
Blank, with earth socket	63 mm x 17.9 mm	60922028-02
PROFIL-mount label holder		
8-pair module, 75 mm profile rod spacing	75 mm x 18 mm	67532008-00
10-pair module, 95 mm profile rod spacing	95 mm x 18 mm	67532009-00

Hinged Label Holder



Description	Dimensions (H x W x D)	Order No.
Hinged label holder Snaps onto LSA-PLUS and LSA PROFIL Series 2, 8- or 10-pair modules, as well as overvoltage magazines. Transparent cover and paper label. Blank Quantity: 1		
8-pair modules	83.3 mm x 11.5 mm	60362005-02
10-pair modules	102.5 mm x 11.5 mm	60892015-01

Number Flags for Series 2 Modules

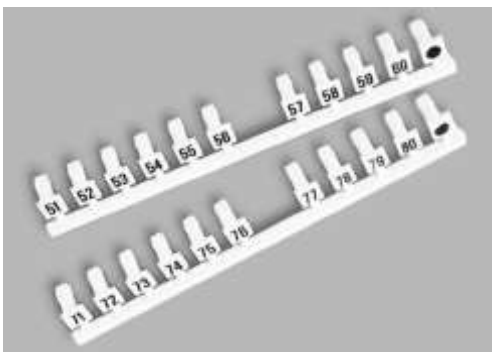

Color	Numbering	Quantity	Order No.
Gray	1....50	1 piece each number	60892077-00
Gray	51....120	1 piece each number	60892077-01
Gray	1....0	10 pieces	60893023-00
Gray	10....100	10 pieces	60893023-01
Gray	1....0	10 pieces	60893023-10
Gray	1....10	10 pieces	60893023-40
Gray	11....20	10 pieces	60893023-41
Gray	21....30	10 pieces	60893023-42
Gray	31....40	10 pieces	60893023-43
Gray	41....50	10 pieces	60893023-44
Gray	51....60	10 pieces	60893023-45
Gray	61....70	10 pieces	60893023-46
Gray	71....80	10 pieces	60893023-47
Gray	81....90	10 pieces	60893023-48
Gray	91....100	10 pieces	60893023-49

Accessories – Insertion Tool with Sensor

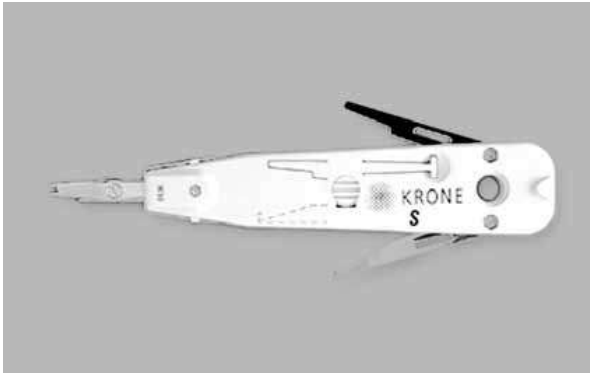

- Used with all LSA-PLUS® modules, as well as with RJ45 jacks and HighBand® modules
- For termination of wires with conductor diameter range 0.35 to 0.9 mm; overall diameter range 0.7 to 2.6 mm
- Features a sensor that detects the end of a wire when a termination has been completed. This feature is deactivated when a second lead is terminated in a contact
- Scissors can be deactivated so that jumper can be through-connected to neighboring contacts
- Service life
 - 0.4 mm wire: 200,000 connections
 - 0.6 mm wire: 100,000 connections
 - 0.8 mm wire: 50,000 connections

Description	Order No.
LSA-PLUS® insertion tool with sensor	64172055-01

Accessories – Simple Insertion Tool

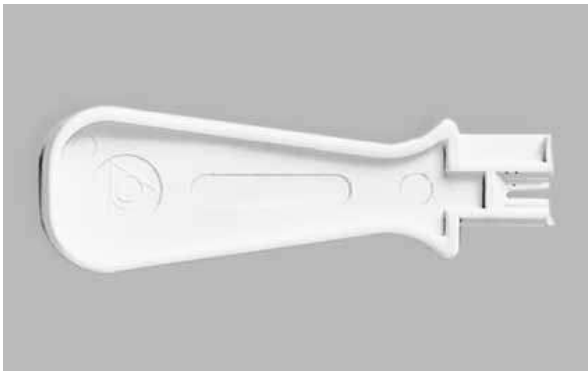

- Used with all LSA-PLUS® modules, as well as with RJ45 jacks and HighBand® modules
- For termination of wires with conductor diameter range from 0.35 to 0.9 mm; overall diameter range 0.65 to 2.6 mm
- No scissors mechanism

Description	Order No.
LSA-PLUS® simple insertion tool	64171830-00

Accessories – Plugs



60893055-XX* Disconnection plug



64173105-05 Dummy plug



60893006-00 Marking cap

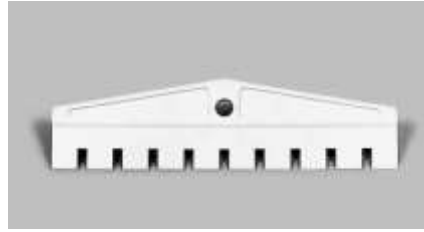

60893130-01 Disconnection plug 10-pair

Description	Order No.
Marking cap - Red color 1-pair. Used for identification of connections Minimum order quantity: 100	60893006-00

Dummy plug

Description	Order No.
Dummy plug - Black color 1-pair. With marking area for identification of lines. Used to prevent access to connection modules or disconnection of disconnection modules Minimum order quantity: 100	64173105-05

Disconnection plug

Description	Order No.
1-pair. Used to interrupt connections in disconnection modules and test adapters Minimum order quantity: 100	60893055-XX*
3-pole. Used to interrupt lines in Series 2 6-pair and 8-pair disconnection modules with shielding Minimum order quantity: 100	64173100-00
10-pair. Used to interrupt 10 pairs at one time in disconnection modules Minimum order quantity: 1 Color: Gray	60893130-01
8-pair. Used to interrupt 8 pairs at one time in disconnection modules Minimum order quantity: 1 Color: Gray	64181811-00

* For color, replace XX with:

Red	00
White	01
Green	02
Yellow	03
Gray	04
Black	05
Brown	06
Blue	07

Accessories – Test Cords

The two-pole test cord features a 4 mm double socket and can be used for almost all LSA-PLUS systems, including NT modules, Series 2, Series 8 or Series 10 modules, as well as two- to eight-pole PCB modules. The cord is used whenever the module's existing test access is already occupied by another plug (such as changeover adapters and/or disconnection adapters) or when a module has no special test access. The spring test contacts connect directly to the wired LSA-PLUS contact. Clamping ribs within the LSA-PLUS contact slot ensure that test plugs are securely retained.



Description	Order No.
2-pole test cord Length: 130 mm	60892141-00

2-pole test cords (for use with LSA-PLUS and LSA-PROFIL modules)

Description	Order No.
1 LSA-PLUS plug, (2) 4 mm banana plugs 2.0 m	66242061-02
1 LSA-PLUS plug, (2) 4 mm banana sockets 0.20 m	66242040-09
2.0 m	66242040-02

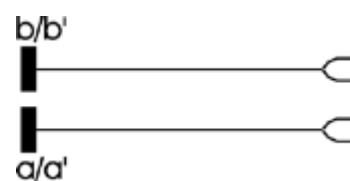

2-pole test cords, 1 side access with disconnection function (for use with LSA-PLUS and LSA-PROFIL disconnection modules)

Description	Order No.
1 LSA-PLUS plug, (2) 4 mm banana plugs 2.0 m	66242521-02
1 LSA-PLUS plug and (2) 4 mm banana sockets 0.20 m	66242320-09

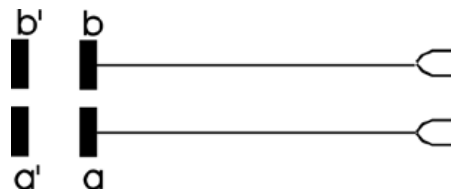
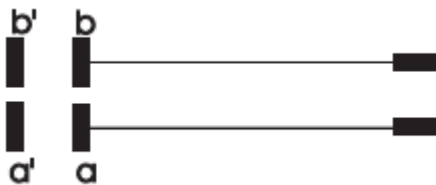

4-pole test cords with disconnection function (for use with LSA-PLUS and LSA-PROFIL disconnection modules)

Description	Order No.
1 LSA-PLUS plug and (4) 4 mm banana plugs 2.0 m	66242541-02
1 LSA-PLUS plug, (4) 4 mm banana sockets 0.20 m	66242340-09

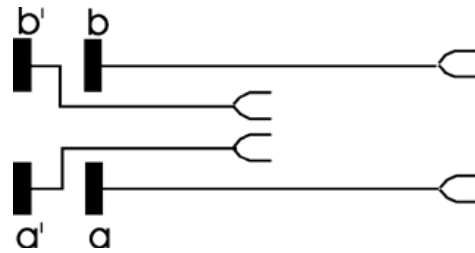
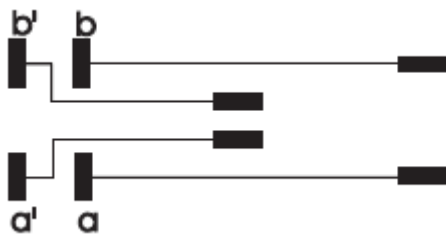

Accessories – Connection Cords

2-pole connection cord (for parallel connections. Features (2) 2-pole plugs)

Description	Order No.
3.0 m	66242081-03

--	--	--

3-pole connection cord with disconnection function (for use with LSA-PLUS and LSA PROFIL disconnection 6- and 8-pair modules with shielding. Features (2) 3-pole plugs, with abc connected)

Description	Order No.
2.0 m	66262801-02

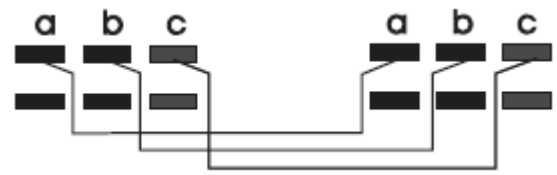
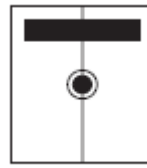

6-pole connection cord with disconnection function (for use with LSA-PLUS and LSA PROFIL disconnection 6- and 8-pair modules with shielding. Features (2) 6-pole plugs, with 1:1 wiring)

Description	Order No.
2.0 m	66262901-02

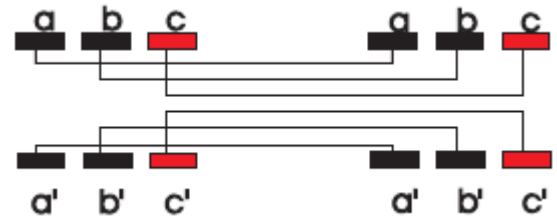
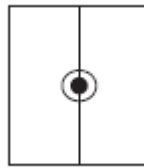

Description	Order No.
Disconnection adapter Opens jumpered line and accesses the line from one side	
1-pair	60892098-00
10-pair, printed 1...0	60892099-00
Changeover adapter For interruption-free changeover of wiring on connection and disconnection modules	
1-pair	60892093-00
10-pair, printed 1...0	60892081-02

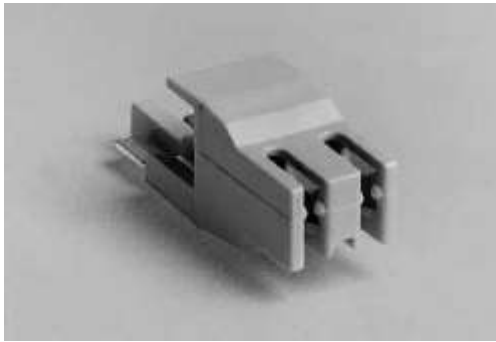

60892098-00 Disconnection adapter 1-pair



60892081-02 Changeover adapter 10-pair

commscope.com

Visit our website or contact your local CommScope representative for more information.

© 2020 CommScope, Inc. All rights reserved.

Unless otherwise noted, all trademarks identified by ® or ™ are registered trademarks, respectively, of CommScope, Inc. This document is for planning purposes only and is not intended to modify or supplement any specifications or warranties relating to CommScope products or services. CommScope is committed to the highest standards of business integrity and environmental sustainability with a number of CommScope's facilities across the globe certified in accordance with international standards, including ISO 9001, TL 9000, and ISO 14001.

Further information regarding CommScope's commitment can be found at www.commscope.com/About-Us/Corporate-Responsibility-and-Sustainability.

Document number: PA-113026-EN