

STOP!

Don't Connect Unless You Inspect!

For Procedure on Inspecting the Fiber, Refer to Section 9

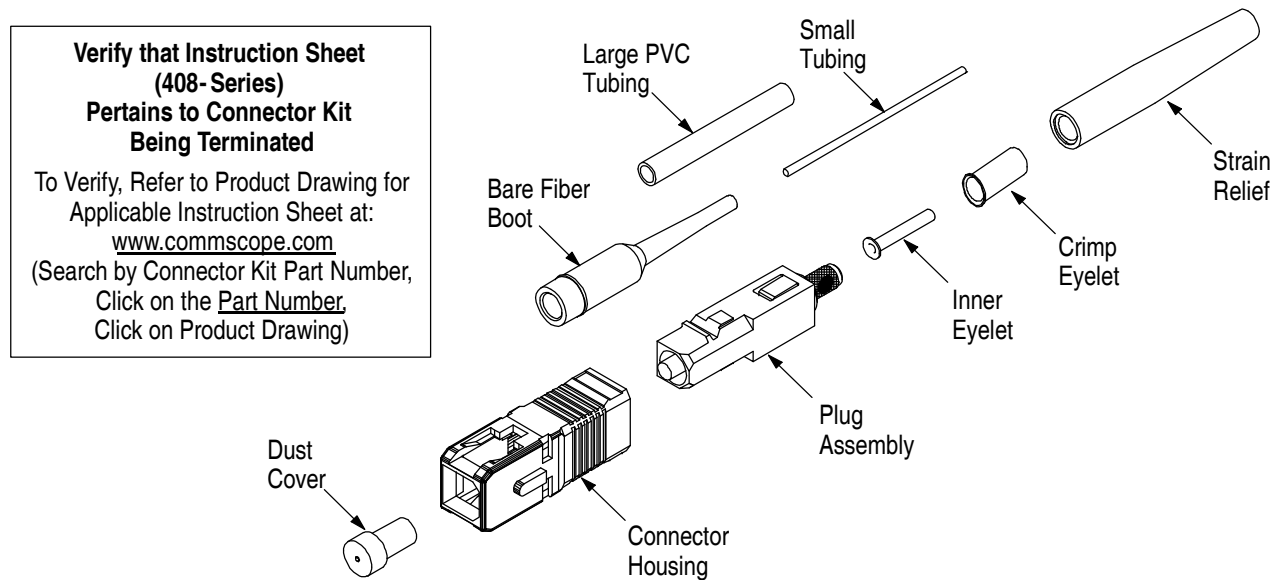

Figure 1

1. INTRODUCTION

LightCrimp SC ceramic multimode simplex and duplex fiber optic connector kits (simplex shown in Figure 1) are designed to be applied to fiber optic cable. The connectors accommodate buffer sizes 250- μm (coated fiber) and 900- μm (tight buffer) and are used with 125- μm glass fiber cable only. Read this material thoroughly before starting assembly.

NOTE Dimensions in this instruction sheet are in metric units [with U.S. customary units in brackets]. Figures are for reference only and are not drawn to scale.

NOTE: Any jacketed cable used with SC connectors must allow for the axial movement of the buffered fiber in the jacket which occurs when the connector is mated to another connector or device. Certain cable constructions do not allow axial movement and are not suitable for use with SC connectors. Refer to Inspection Specification 129-1496 for a method of determining whether a given cable construction allows axial movement (result of the buffer pull test).

These connectors are fully compatible with OPTIMATE* SC connectors (that require epoxy) and all other manufacturer SC multimode connectors (that do or do not require epoxy).

NOTE Coupling Receptacle Kit 5502632-[] is used to mate two simplex SC connectors and Coupling Receptacle Kit 5502776-[] is used to mate two duplex SC connectors in free-hanging or panel-mount applications.

These instructions apply only to LightCrimp SC ceramic multimode connector kits when used with jacketed cable, buffered fiber, or coated fiber.

Reasons for reissue of this instruction sheet are provided in Section 10, REVISION SUMMARY.

2. DESCRIPTION

The simplex connector kit consists of a dust cover, connector housing, plug assembly, crimp eyelet, inner eyelet, strain relief, bare fiber boot, small tubing, and large PVC tubing. The duplex connector kit consists of two of each of these components.

The large PVC tubing is used only with cables having a jacket diameter less than 3.0 mm [.12 in.] or greater

than or equal to 2.3 mm [.09 in.]. The bare fiber boot is used with 900- μ m tight buffer or 250- μ m coated fiber. The small tubing is used to build up a 250- μ m coated fiber to 900 μ m. Only the connector housing, plug assembly, crimp eyelet, inner eyelet, and strain relief boot are needed for cable constructions having a 900- μ m tight buffer, strength members, and nominal jacket diameter of 3.0 mm [.12 in.].

3. REQUIRED TOOLS AND MATERIALS

3.1. Tools

- Cable Preparation Template 503694-1
- Cable Stripper 501198-1 (408-9394)
- Scissors 501014-1
- Micro-Strip Stripper (203 μ m [.008 in.]) 492109-2
- Fiber Optic Combination Strip Tool 1754708-1
- LightCrimp Plus* SC Die Set with Crimping Tool 492782-1 (consists of Die Set 492783-1 and PRO-CRIMPER* III Hand Tool 2064431-1)
- Polishing Bushing (Metal) 503787-1 or Polishing Bushing (Plastic) 502631-1
- Cleave Tool Assembly 503705-1
- Polishing Plate 501197-1
- Polishing Pad 504584-1
- 200 \times Microscope Kit 1754767-1 (Includes 2.5-mm Adapter Cap) or 100 \times microscope

Supplemental

- Sapphire Pen Cleave Tool 504064-1 (408-4293)

3.2. Consumable Materials

- 5- μ m Polishing Film 228433-8
- 0.3- μ m Polishing Film 228433-5
- isopropyl alcohol
- lint-free tissues

NOTE  Termination Kits 503706-[] consist of tools and materials (except the isopropyl alcohol and lint-free tissues) required to assemble these connectors. Termination Kit 503706-1 does not include a microscope. Kit -2 does include a microscope.

4. PREPARATION

4.1. Preparing Fibers

DANGER  To avoid personal injury, ALWAYS wear eye protection when working with optical fibers. NEVER look into the end of terminated or unterminated fibers. Laser radiation is invisible but can damage eye tissue. NEVER eat, drink, or smoke when working with fibers. This could lead to ingestion of glass particles.

DANGER  CAREFULLY DISPOSE OF FIBER ENDS. The fibers create slivers that can easily puncture the skin and cause irritation.

A. Jacketed Cable

1. If using cable with a jacket diameter less than 3.0 mm [.12 in.], slide the large PVC tubing over the cable jacket. See Figure 2.
2. Slide the strain relief (small diameter end first) over the cable jacket. See Figure 2.

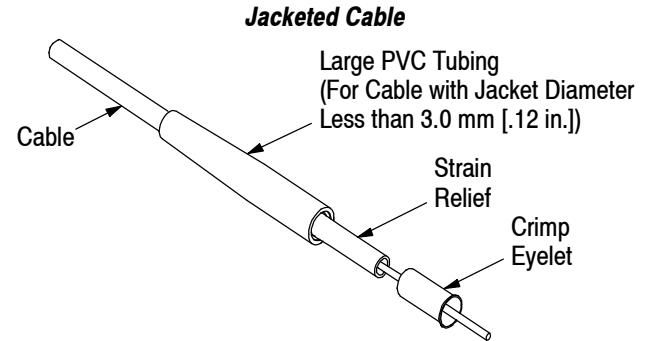



Figure 2

3. Using the cable stripper, strip the cable jacket to the dimension given in Figure 3 or use the cable preparation template.

NOTE  The cable preparation template is drawn to scale.

4. Using the scissors, trim the strength members to the dimension given in Figure 3 or use the cable preparation template.
5. Slide the crimp eyelet onto the buffer. Using the crimp eyelet, push the strength members to one side of the cable jacket. Fold back the strength members and retain them with the crimp eyelet. See Figure 4, Detail A.
6. Slide the inner eyelet over the buffer and under the cable jacket and strength members until the inner eyelet bottoms. See Figure 4, Detail B.
7. Mark the buffer to the dimension given in Figure 3 or use the cable preparation template, and using the micro-strip stripper, strip the buffer and coating to the marking. Several steps may be needed to remove all of the buffer and coating.

CAUTION  Make sure that the stripper removes the clear coating from the fiber. If the clear coating remains on the fiber, the prepared fiber will stub in the connector and will not pass through.

Stripping Dimensions (mm [in.])

Note: Not to Scale

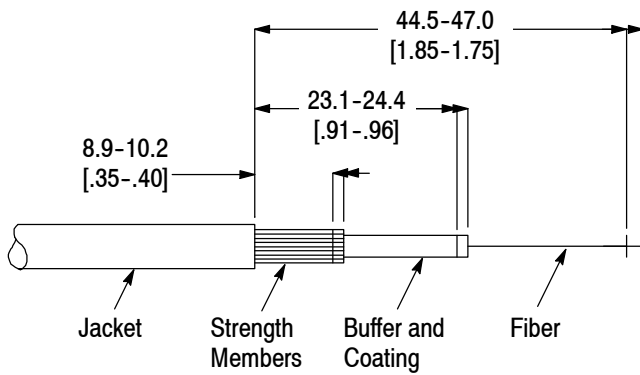
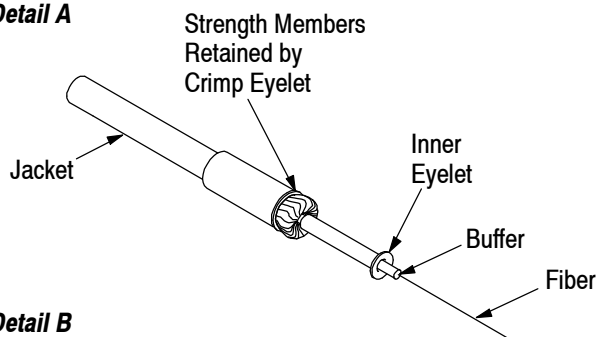

Figure 3

Detail A



Detail B

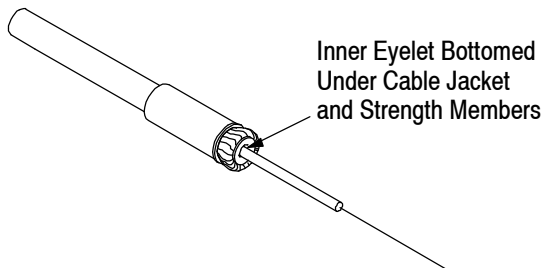
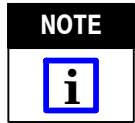

Figure 4



Debris from the buffer tends to remain in the stripper. A good practice is to tap the stripper on a soft surface to remove the debris immediately after stripping the buffer.

8. Remove debris from the fiber by wiping the stripped fiber with a lint-free tissue dampened with isopropyl alcohol.

B. 900- μ m Buffered Fiber

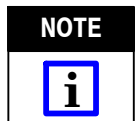

Only the plug assembly and bare fiber boot are used to prepare 900- μ m buffered fiber.

900- μ m Buffered Fiber and 250- μ m Coated Fiber

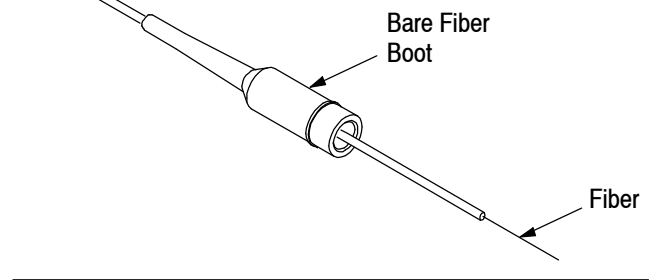
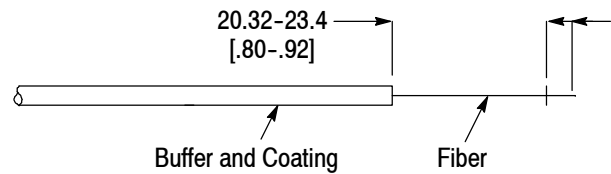

Figure 5

Stripping Dimensions (mm [in.])

900- μ m Buffered Fiber



Note: Not to Scale

250- μ m Coated Fiber

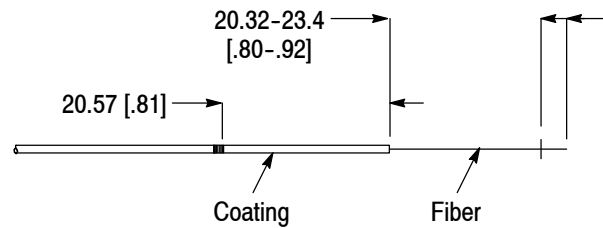
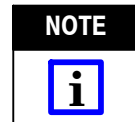

Figure 6

1. Slide the bare fiber boot (small diameter end first) onto the buffered fiber as shown in Figure 5.
2. Using the micro-strip stripper, remove the buffer and the coating from the fiber within the dimensions given in Figure 6. Several strips might be required to remove all of the buffer and coating.



Make sure that the stripper removes the clear coating on the fiber. If the clear coating remains on the fiber, the prepared fiber will stub in the connector and will not pass through.



Debris from the buffer tends to remain in the stripper. A good practice is to tap the stripper on a soft surface to remove the debris immediately after stripping the buffer.

3. Remove debris from the fiber by wiping the stripped fiber with a lint-free tissue dampened with isopropyl alcohol.

C. 250-µm Coated Fiber

Various fiber preparations and terminations are possible with this type of fiber.

If a breakout kit is used where the 250-µm coated fiber is inserted into a breakout cable with strength members, follow Paragraph 4.1, A. Instead of stripping the buffer, remove the fiber coating using the micro-strip stripper and insert the small tubing into the plug assembly before inserting the fiber.

If a breakout kit is not used, the fiber end and terminations should be housed in a limited-access protective enclosure.

NOTE *Only the plug assembly and bare fiber boot are used to prepare 250-µm coated fiber.*

1. Slide the bare fiber boot (small diameter end first) onto the coated fiber as shown in Figure 5.
2. Using the fiber combination strip tool, strip the fiber coating within the dimensions given in Figure 6.
3. Mark the fiber coating behind the fiber coating interface to the dimension given in Figure 6.
4. Insert the small tubing into the plunger of the plug assembly until it protrudes from the knurled end of the plug assembly to the dimension given in Figure 7.

NOTE *If the small tubing protrudes more than the recommended dimension, re-insert the tubing into the plunger. When the first obstruction is felt, move the tubing rapidly inward and outward until the tubing protrudes to the recommended dimension.*

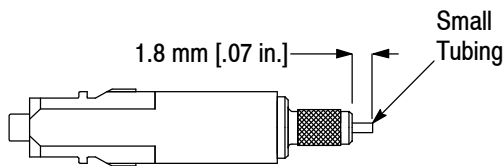

Figure 7

5. Remove debris from the fiber by wiping the stripped fiber with a lint-free tissue dampened with isopropyl alcohol. For gel-filled cables, all gel must be removed by wiping it with a suitable cleaning material.

5. TERMINATION PROCEDURE

CAUTION *The die set and crimping tool given in Paragraph 3.1, A must be used to terminate this connector. Make sure that the proper tooling is used by verifying the part number stamped on the die set and tool.*

5.1. Terminating Jacketed Cable

1. Insert the cable through the knurled end of the plug assembly. A slight rotating motion may be necessary to center the fiber in the plug assembly. While slightly rotating the plug assembly, gently push the fiber through the knurled end until it protrudes from the ferrule face, and the buffer bottoms in the plug assembly. Approximately 12.7 mm [.50 in.] of fiber should protrude from the ferrule face of the plug assembly.
2. Squeeze the tool handles until the ratchet releases. Open the tool handles fully.
3. Gently close the tool handles until there is one audible click from the ratchet.
4. Position the plug assembly in the dies so that the fiber is facing in the same direction as the arrow on the die set. Carefully insert the fiber into the small width slot of the die set. The knurled end of the plug assembly should be positioned in the large width slot of the die set. See Figure 8.

CAUTION *To prevent the fiber from breaking, be careful when positioning the plug assembly in the dies.*

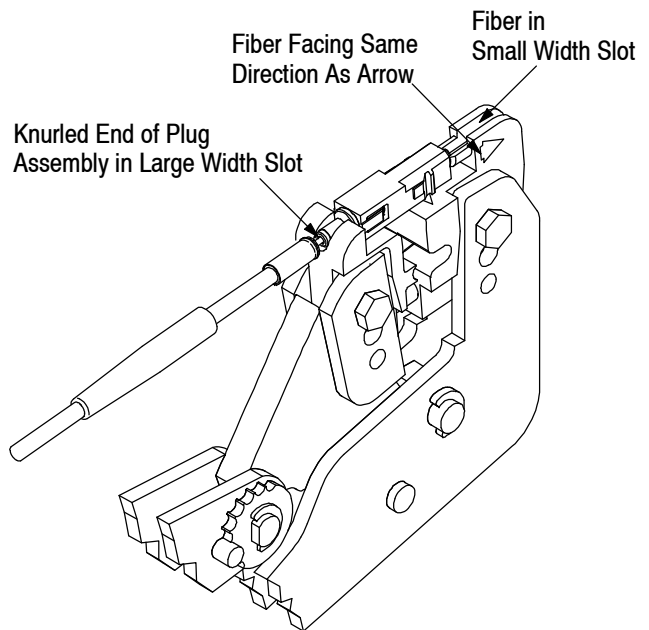

Figure 8

5. Squeeze the tool handles together while gently pushing on the cable to ensure that it follows the insertion of the plunger. Squeeze the tool handles until the ratchet releases. Open the tool handles fully while holding the plug assembly. Remove the plug assembly by sliding the knurled end out of the die set. *Be careful not to break the exposed fiber.*

6. Slide the crimp eyelet away from the plug assembly so that the strength members are exposed. Gently push on the plug assembly so the gap between the knurled end of the plug assembly and the cable jacket is small enough to allow the strength members to completely cover the knurled end of the plug body. See Figure 9.

7. Slide the crimp eyelet forward over the strength members, retaining the strength members against the knurled end of the plug assembly.

8. Insert the crimp eyelet and plug assembly into the dies as shown in Figure 10. The plug assembly is properly oriented if the fiber is facing in the same direction as the arrow located on the recessed area of the die set. See Figure 10.



The crimping chamber for the crimp eyelet is stepped. Ensure proper orientation of the plug assembly in the die. Applying a crimp eyelet to an improperly oriented plug assembly can damage the tool and plug assembly. If necessary, the ratchet can be released without fully closing the handles by gently prying the lever at the ratchet area with a probe, such as a screw driver.

9. Squeeze the tool handles together until the ratchet releases. Open the tool handles fully, and remove the crimped plug assembly. *Be careful not to break the exposed fiber.*

10. If using cable with a jacket diameter less than 2.3 mm [.09 in.], slide the large PVC tubing and strain relief over the crimp eyelet until the tubing is positioned against the plug assembly.

11. Slide the strain relief boot over the crimp eyelet until it bottoms.

5.2. Terminating 900-µm Buffered Fiber or 250-µm Coated Fiber

1. Insert the cable through the knurled end of the plug assembly. A slight rotating motion may be necessary to center the fiber in the plug assembly. While slightly rotating the plug assembly, gently push the fiber through the knurled end until it protrudes from the ferrule face, and the buffer bottoms in the plug assembly. Approximately 12.7 mm [.50 in.] of fiber should protrude from the ferrule face of the plug assembly.

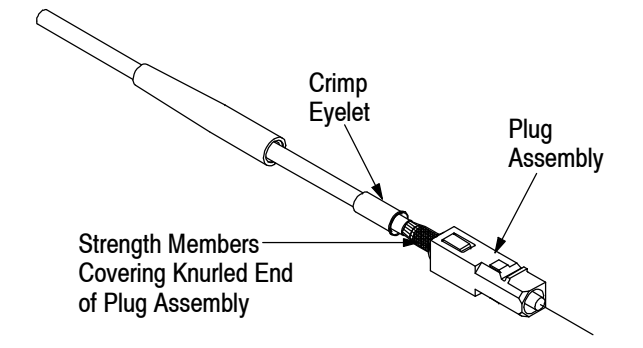

Figure 9

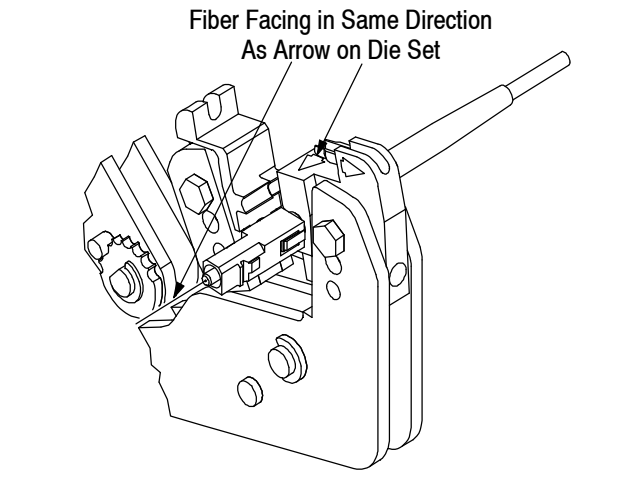
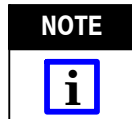
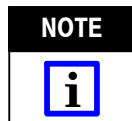

Figure 10



For 250-µm coated fiber, make sure that the mark made on the coating is visible just beyond the edge of the small tubing at the back of the plug assembly.



For multi-fiber cable, orient all plug assemblies the same way during crimping.

2. Squeeze the tool handles until the ratchet releases. Open the tool handles fully.

3. Gently close the tool handles until there is one audible click from the ratchet.



To prevent the fiber from breaking, be careful when positioning the plug assembly in the dies.

4. Position the plug assembly in the dies so that the fiber is facing in the same direction as the arrow on the die set. Carefully insert the fiber into the small width slot of the die set. The knurled end of the plug assembly should be positioned in the large width slot of the die set. See Figure 8.

5. Squeeze the tool handles together fully until the ratchet releases. Open the tool handles fully while holding the plug assembly. Remove the plug assembly by sliding the knurled end out of the die set. *Be careful not to break the exposed fiber.*

6. Slide the bare fiber boot over the knurled end of the plug assembly.

6. CLEAVING THE FIBER

1. Insert the plug assembly into the cleave tool so that the protruding fiber is guided through the slot in the tool. See Figure 11.

2. Make sure that the fiber extends beyond the edge of the cleave tool. If it does not, scribe the fiber using the sapphire pen scribe tool as follows:

- a. Hold the blade between a 3 and 5° angle (about the diameter of one fiber) from the surface of the ferrule, and gently brush the blade across the fiber. See Figure 12.

CAUTION *DO NOT apply force to the fiber with the blade while scribing since excessive force may fracture the fiber inside of the ferrule making the connector unusable.*



CAUTION *If the cleave tool is not used properly, the diamond blade will be damaged.*



CAUTION *All screws on the tool are factory preset. Adjustments will result in poor cleaves.*



- b. Grasp the protruding fiber lightly between the thumb and forefinger; then pull in line with the connector. If the fiber does not scribe easily, re-scribe the fiber and try again. A proper scribe, close to the ferrule surface, is essential for obtaining a successful fiber polish.

3. Push the plug assembly ferrule into the bore until the ferrule stops at the pan head screw.

4. Gently depress the tool actuator button to cleave the fiber.

DANGER *To avoid personal injury, hold the plug assembly away from your face when pushing the actuator button.*



CAUTION *To safely dispose of the cleaved fiber, invert the cleaving tool and plug assembly over a container, or use a piece of masking tape (with the sticky side facing up) to catch the fiber.*

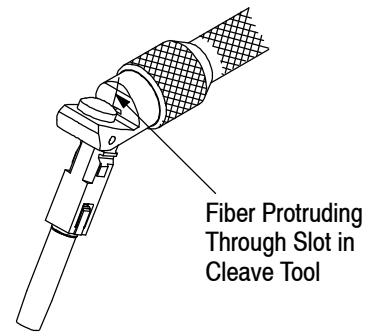



Figure 11

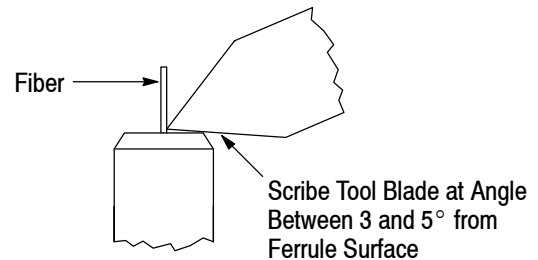

Figure 12

5. If the fiber is not polished immediately, place the dust cap onto the plug assembly.

7. POLISHING THE FIBER

Initially, the polishing plate has protective paper covering both sides. Remove the paper from both sides of the polishing plate. The resilient pad is backed with adhesive. Remove the backing from the pad and place it on the polishing plate. Smooth the pad using your hand.

1. Cut a small piece (50 by 50 mm [2 by 2 in.]) of the 5-µm polishing film.

2. Hold one end of the polishing film between the index and middle fingers, and hold the other end between the thumb and ring finger with the abrasive side of the film facing up. Pull the film taut, and air polish the connector tip by gently rubbing the tip of the connector in small circles (or figure-8 pattern) until the protruding stub of the cleaved fiber no longer makes scratches on the film. See Figure 13.

CAUTION *During the initial stages of polishing, be careful to avoid breaking off the fiber inside of the ferrule, thereby making the connector unusable.*



3. Place a piece of the .3-µm polishing film on top of the resilient pad.

4. Gently insert the connector into the polishing bushing (the connector will snap into place).

Method of Holding Polishing Film

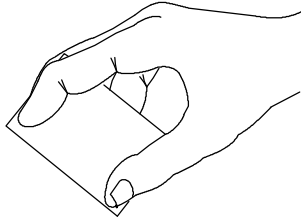

Figure 13

5. Place the plastic polishing bushing onto the polishing film and move the bushing in a figure-8 pattern while supporting the weight of the bushing for the first three figure-8 patterns to prevent the fiber from breaking or scoring the film.



Scored film should be replaced immediately to prevent fiber breakage.



DO NOT wet the polishing film with water. These connectors require a dry polish.

6. Using gentle pressure on the bushing, continue polishing for 25 to 30 more figure-8 patterns.

7. Remove the connector from the polishing bushing, and clean it with a lint-free cloth or tissue. Dabbing the ferrule end face on a resilient piece of tape will remove any stubborn polishing grit. Using a lint-free cloth lightly dampened with isopropyl alcohol will remove any tenacious debris from the end face.



A protruding fiber (PF) polish often provides superior connector performance. It is recommended to leave the fiber protruding slightly (approximately 5 μm [.0002 in.] from the ferrule surface.

8. Place the plug assembly in the appropriate receptacle or if the assembly will not be used immediately, place the dust cap onto the plug assembly.

8. ASSEMBLING THE CONNECTOR

1. Insert the plug assembly into the connector housing. The key on the housing must be toward the front (fiber end) and must line up opposite to

the completely flat side of the plug assembly. The housing should align with the plug assembly as shown in Figure 1.

2. Push the base of the plug assembly and the connector housing until the two snap together. The housing should slide back and forth approximately 3 mm [.125 in.] on the plug assembly. Pull the bare buffer boot back, then feed the fiber through the slot in the tool, and push the plug assembly forward until the plug assembly and housing snap together. Push the bare fiber boot forward to protect the fiber.

STOP!
Don't Connect Unless You Inspect!

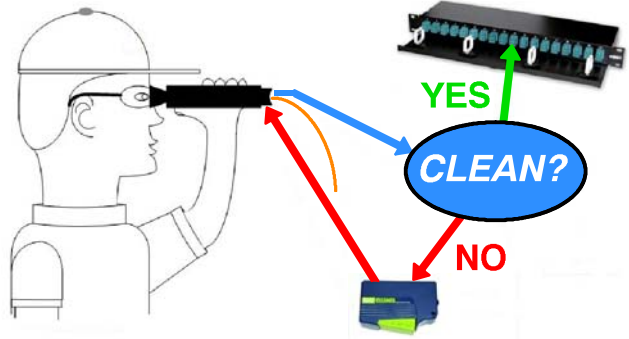

DANGER: Never View Active Fiber Signals

9. INSPECTING THE FIBER



ALWAYS DISCONNECT the cable from the power signal source before inspecting the fiber. The infrared light used, although it cannot be seen, can cause injury to the eye.

1. Using the microscope, inspect the fiber. If possible, place the far end of the fiber near a bright light. Compare the fiber end to the examples shown in Figure 14, and take any recommended action.

2. Verify that the fiber is flush with (or is protruding slightly from) the ferrule surface by moving the microscope focus control. If the fiber and the ferrule surface come into focus together, the fiber is flush. If the fiber comes into focus before the ferrule surface (when moving toward the end face), the fiber is protruding too much and additional polishing on the .3-μm film is required.

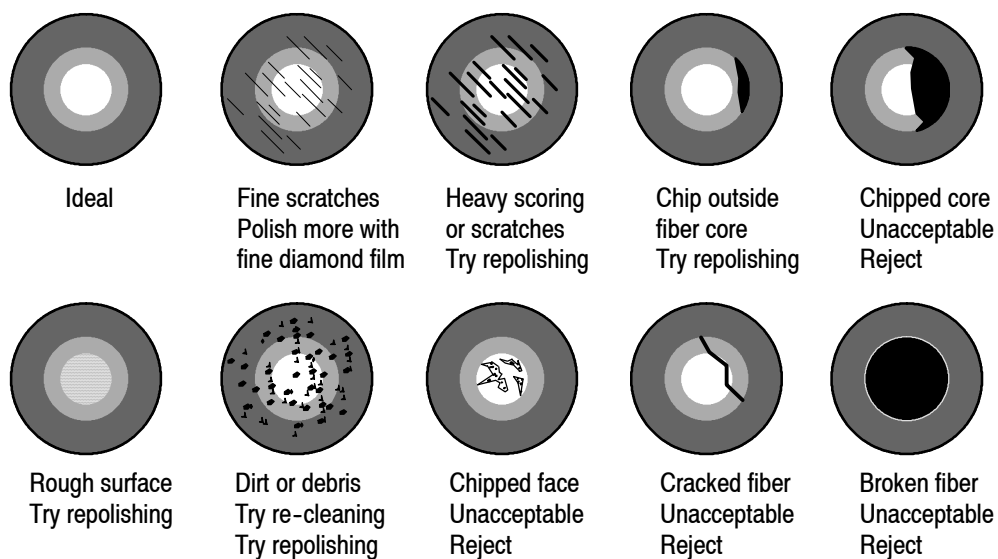

Figure 14

10. REVISION SUMMARY

Revisions to this instruction sheet include:

- Changed company name and logo