

Installation Guidelines - – HELIAX® FiberFeed® Solutions

Fiber/Copper Cables: HFT1206 | HFT806 | HFT406 | HFT412

Related Support and Learning Opportunities Offered by the CommScope Infrastructure Academy

The insights and expertise contained in this manual represent just one small part of Andrew Solutions' global learning initiative. Few industries are evolving as quickly as wireless communications. Every technological innovation impacts what happens in the field. Our customers look to the CommScope Infrastructure Academy to make sure their technicians and installers are well trained, well-prepared, and well-educated to take advantage of opportunities as they evolve. To access a course, go to www.commscopetraining.com/coursecatalog.php, course #6107.

Field Engineering Services (FES)

Support services, such as our Field Engineering Services (FES) Group gives Andrew Solutions' customers access to technical support where and when it is needed the most — in the field. The FES team is staffed by an expert team of technicians who, in turn, are supported by some of the brightest and most experienced product line managers. With all of this knowledge and support the FES offers our customers access to hands-on, specialized training classes.

Section 1: System Components	02
Section 2: General Specifications	03
Section 3: HELIAX® FiberFeed® Trunk Cables	04
Section 4: HELIAX® FiberFeed® Jumpers	05
Section 5: Breakout Procedure / LC Connection Considerations	06
Section 6: All-in-One Cleaner / Inspecting	07
Section 7: OVP Identification / Gland Installation	08
Section 8: Color Code	09
Section 9: Grounding	10
Section 10: Excess Cable Management	11
Section 11: Inspection Check list	12

For more information, Contact Customer Service Center

United States and Mexico 1-800-255-1479 or 1-888-235-5732
International: +1-779-435-8579

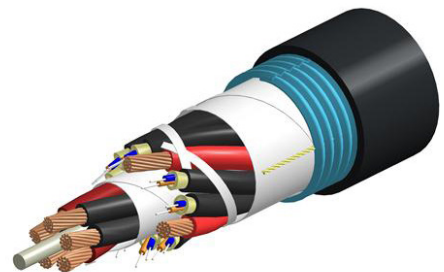

HELIAX® FiberFeed® Verizon System Components

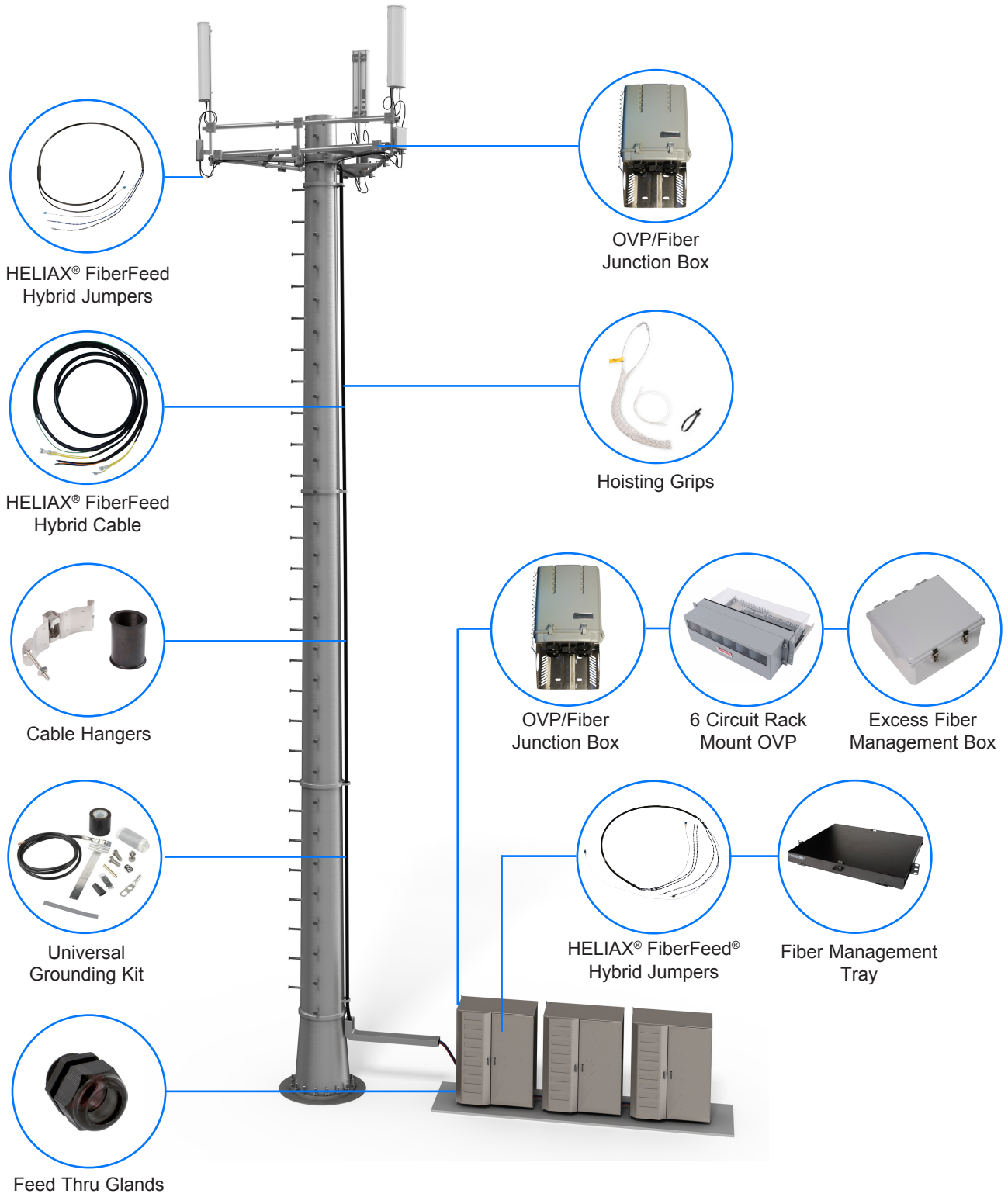

WARNING: CommScope Hybrid FiberFeed cables require the use of approved installation accessories.

General Specifications

Cable Type	HFT1206-24S49-XXX	HFT806-16S48-XXX	HFT406-8S48-XXX
Rating	UL Type TC-OF-ER	UL Type TC-OF-ER	UL Type TC-OF-ER
Center Conductor Gauge	6 AWG	6 AWG	6 AWG
Conductors, quantity	12	8	4
Total Fiber Quantity	24	16	8
Shielding Type	Corrugated aluminum	Corrugated aluminum	Corrugated aluminum
Fiber Type	Bend insensitive singlemode	Bend insensitive singlemode	Bend insensitive singlemode
Alarm Wire (Qty Gauge)	18 18 AWG	14 18 AWG	10 18 AWG

Dimensions

Cable Weight	1.78 lb/ft	1.24 lb/ft	.772 lb/ft
Diameter Over Jacket	1.56 in	1.3 in	1.12 in
Breakout Length, Fiber, end 1	39 in	39 in	23 in
Breakout Length, Power, end 1	29 in	29 in	23 in
Breakout Length, Fiber, end 2	39 in	39 in	23 in
Breakout Length, Power, end 2	29 in	29 in	23 in

Physical Specifications

Minimum Bend Radius, loaded	31 in	26 in	22 in
Minimum Bend Radius, unloaded	15.6 in	13 in	11 in
Tensile Load, long term, maximum	450 lbf	240 lbf	180 lbf
Tensile Load, short term, maximum	1500 lbf	800 lbf	600 lbf

General Specifications

Cable Type	HFT412-2SXX-XX	HFT412-4SXX-XX
Rating	UL Type TC-OF-ER	UL Type TC-OF-ER
Center Conductor Gauge	12 AWG	12 AWG
Conductors, quantity	4	4
Total Fiber Quantity	2	4
Shielding Type	Corrugated aluminum	Corrugated aluminum
Fiber Type	Bend insensitive singlemode	Bend insensitive singlemode

Dimensions

Cable Weight	.220 lb/ft	.220 lb/ft
Diameter Over Jacket	.62 in	.62 in
Breakout Length, Fiber, end 1	various	various
Breakout Length, Power, end 1	various	various
Breakout Length, Fiber, end 2	various	various
Breakout Length, Power, end 2	various	various

Physical Specifications

Minimum Bend Radius, loaded	12.4 in	12.4 in
Minimum Bend Radius, unloaded	6.2 in	6.2 in
Tensile Load, long term, maximum	90 lbf	90 lbf
Tensile Load, short term, maximum	300 lbf	300 lbf

Trunk Fiber Feeder

- In general this cable will handle similarly to coaxial cable, and similar installation techniques apply. All cables are individually serialized, be sure to write down the cable serial number for future reference.
- The terminated fiber ends (the broken out fibers plus connectors) however are fragile, and these must be protected during the installation process.
- Leave the protective tube and sock around the fiber tails and connectors in place during hoisting and securing the cable. Remove this only just prior to making the final connections to the Junction box.
- DO NOT BEND THE FIBER ENDS (in the furcation tubes) TIGHTER THAN 1.2" (30mm) BEND RADIUS ELSE THERE IS A RISK OF BREAKING THE GLASS FIBERS.
- Be sure that the lace up ends and fiber connectors are not damaged by attachment of a hoisting grip or during the hoisting process. Attach a hoisting grip on the jacketed cable no less than 6" below the fiber breakout point. If a hoisting grip is not easily attached, use a simple line attached below the fiber break-out point (i.e. at the cable outer jacket). Prevent the fiber tails (in protective tube) at the cable end from undue movement during hoisting by securing the protective tube (with outer sock) to the hoisting line.
- During hoisting ensure that there is a free path and that the cable, and especially the fiber ends, will not be snagged on tower members or other obstacles.
- Installation temperature range is -22F to 158F
- Minimum cable bend radii can be found in this document or on-line.
- Maximum cable tensile load can be found in this document or on-line.
- **CommScope Lace-Up Hoisting Grip 19256B-C required for 406 and 806 installations.**
- **CommScope Lace-Up Hoisting Grip 29961-C required for 1206 installations.**
- **Maximum hanger spacing 3ft (0.9m) - 4ft (1.2m)**

⚠ Hybrid Fiber Cables weigh more than traditional coaxial cables. Be sure to follow proper hoisting and attachment procedures.

Hoisting Recommendations

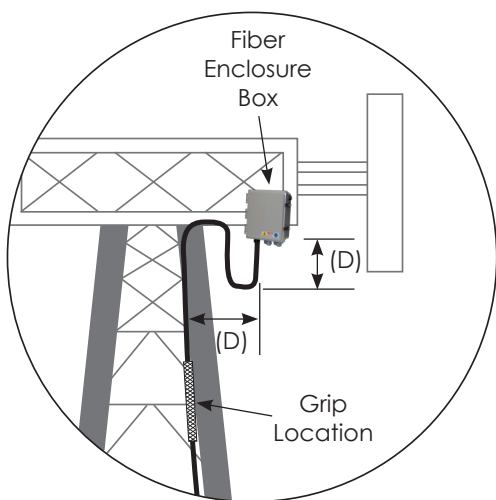

Reminder: Plan grip location by measuring distance (D) from Fiber Enclosure Box to tower support member.

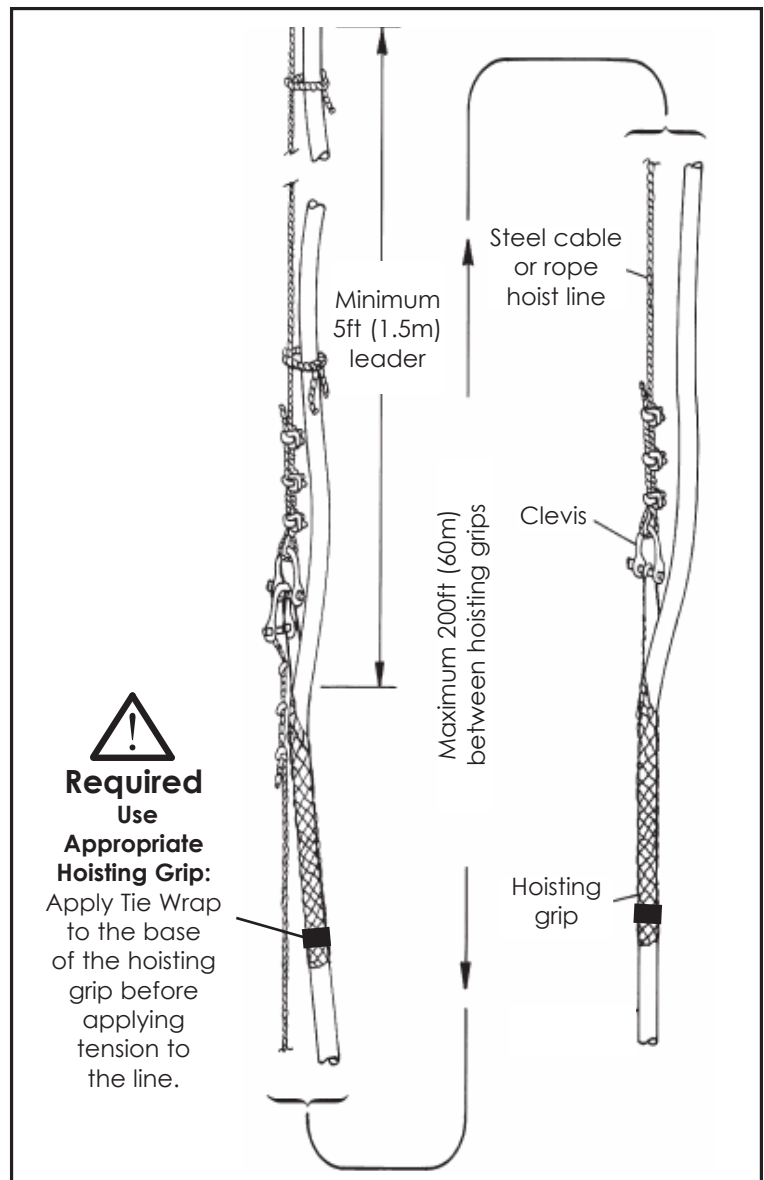

Jumper Assemblies

- In general this cable will handle similarly to a coaxial cable.
- The terminated fiber ends however are fragile and must be protected during installation. Leave the packaging around the fiber ends in place until ready to connect the jumper between OVP box and RRU or BBU.
- DO NOT BEND THE FIBER ENDS (in the furcation tubes) TIGHTER THAN 1.2" (30mm) BEND RADIUS ELSE THERE IS A RISK OF BREAKING THE GLASS FIBERS.
- Attach the main cable securely to the structure or equipment using hangers and/or cable ties to prevent strain on connections from movement in wind or snow/ice conditions.
- Ensure the LC fiber connectors are seated firmly in the OVP box, RRU or in BBU equipment.
- Ensure the weatherproof boots for both fiber and power connections and seated firmly in the RRU.
- Heat shrink tube of the jumper should be 1" (25.40mm) inside of the OVP box.
- Installation temperature range is -22F to 158F (-30C to 70C).
- Minimum cable bend radii can be found in this document or on-line.
- Standard lengths available are 3-6-9-12-15-30 foot.
- All jumpers are individually serialized, for immediate access to test results visit www.commscope.com/webtrak/
- Power connector is supplied with the RRU
- Blue power conductor is -48V
- Black power conductor is 0V (return)
- RRU/BBU connectivity per OEM instruction

HFT412-2S28 Hybrid tails, 2 Fiber - RRU to 2-OVP Box
HFT412-2S29 Hybrid tails, 2 Fiber - RRU to 6-OVP Box

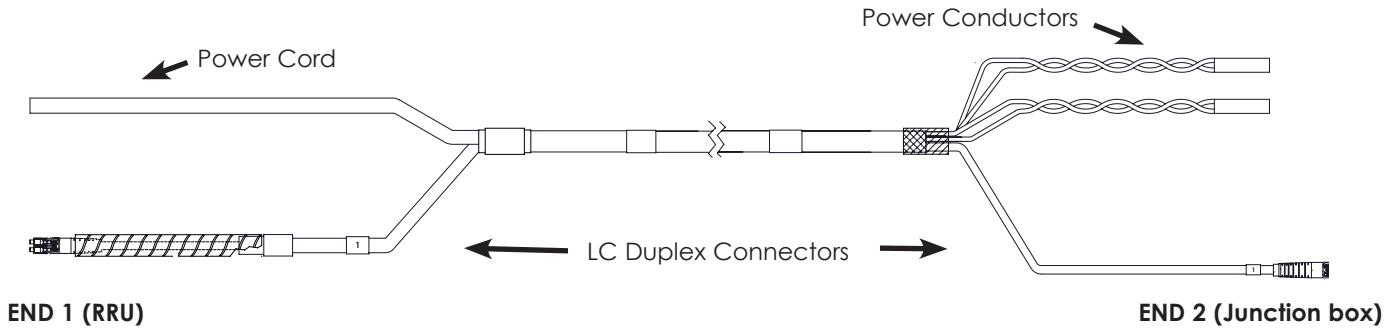

HFT412-2S27 Hybrid tails, 2 Fiber - BBU to 2-OVP Box

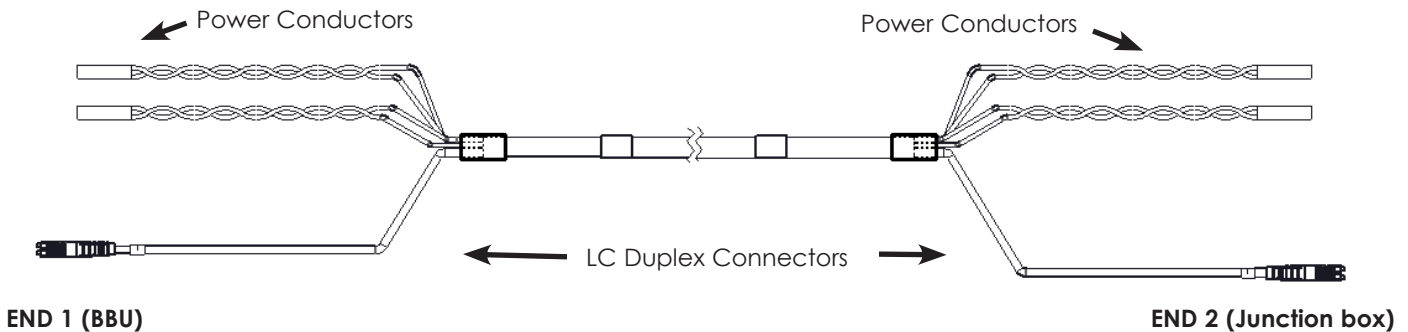

Breakout Procedure

After the trunk cable has been installed and you are ready to make the final connection to the OVP box follow these steps for the removal of fiber protection tube.

1



Remove electrical tape from the trunk cable and corrugated protection tube

2



While holding the protection tube straight pull the tube away from cable.

3



After you have pulled the fiber and power conductors into the OVP box remove electrical tape from the trunk cable and remove clear tube for access to all optical connectors.

LC Connectors and Adapter cleaning

Clean exposed connector ferrule by lightly moistening lint-free wipe with fiber optic cleaning solution (or >91% isopropyl alcohol), and by applying medium pressure, first wipe against wet area and then onto dry area to clean potential residue from end face. Clean connector ferrule inside adapter by inserting lightly moistened cleaning stick with fiber optic cleaning solution (or >91% isopropyl alcohol) inside the adapter until contact is made with connector on opposite end. Rotate cleaning stick with medium pressure in one circular motion as it is pulled away from the adapter. Repeat process using dry cleaning stick.

Caution: Signal strength will be affected if end and sides of ferrule are not thoroughly cleaned. Discard cleaning sticks after each use. Do not turn cleaning sticks back and forth pressing against connector end face. This may cause scratches if large contamination is present. Always inspect connector end face for contamination after each cleaning.

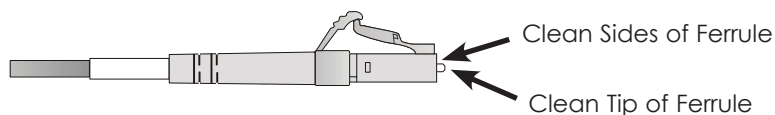

Clean adapter by inserting adapter cleaning stick (or fiber adapter sleeve brush) moistened with fiber optic cleaning solution (or >91% isopropyl alcohol) inside the adapter and gently pull out with twisting motion. Repeat process with a dry cleaning stick.

Caution: Do not try to clean adapter with a standard pipe cleaner. The sleeve inner diameter of LC adapters is too small. Do not try to clean the adapter with cleaning stick if a connector is mounted in one side. Discard cleaning sticks after each use.



All in one cleaner

Device designed for cleaning the ferrule end faces of LC connectors

Open guide cap, insert LC connector into guide, push the outer shell to start cleaning the LC connector interface, a "click" sound indicates end of a cleaning process, repeat, close cap immediately after use.

Caution: Be careful not to slant LC connector while inserting into the Guide cap. Do not overly exert force during insertion as this may cause damage to both the connector and the cleaner.

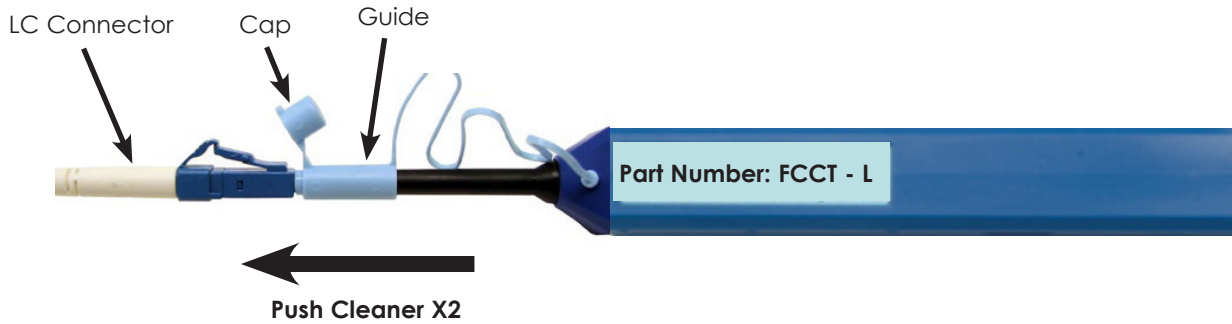

Inspecting

There are 3 basic principles that are critical to achieving an efficient fiber optic connection:

1. Perfect Core Alignment
2. Physical Contact
3. Pristine Connector Interface

Today's connector design and production techniques have eliminated most of the challenges to achieving core alignment and physical contact. What remains challenging is maintaining a pristine end-face. As a result, CONTAMINATION is the #1 reason for troubleshooting optical networks.

Implementing the process of cleaning and inspecting before mating can reduce the time spent troubleshooting, optimize signal performance and prevent damage.

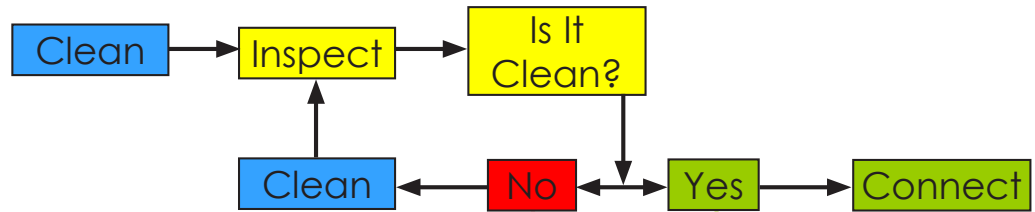

Abrasive particles (i.e. rock dust) can cause permanent damage to the interface. If interface is scratched it cannot be repaired, it would need to be replaced.

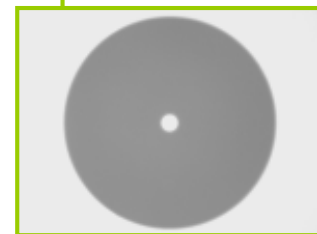
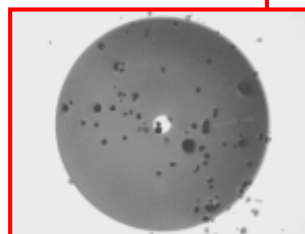

OVP Identification

Part Number	Description	Excess Fiber Storage
RC3DC-3315-PF-48*	Distribution box with 6 Strikesorb modules	55 ft
RC3DC-4750-PF-48*	Distribution box with out Strikesorb modules	55 ft
RC3DC-1064-PF-48*	Sector box with 2 Strikesorb modules	45 ft
RCMDC-2260-RM-48*	6 circuit rack mount OVP	N/A



Note: *

RC3DC-XXXX-PF-48 couples with HFT series cables (accommodates expanded alarm wire pairs)

Gland Installation

At the base of the OVP boxes there are glands that provide weatherproofing for the enclosure. The following steps will show how to install the Hybrid cable properly.

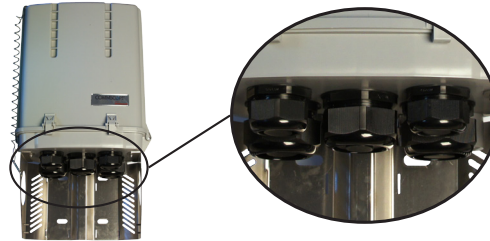

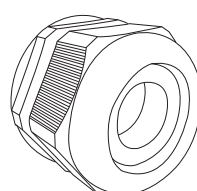
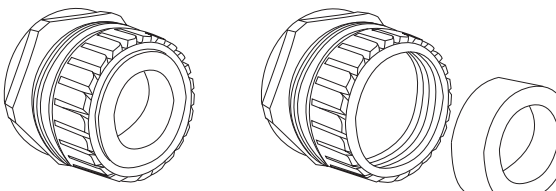
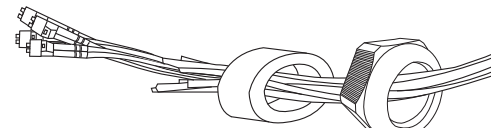
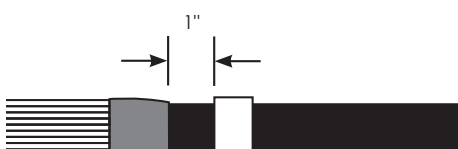
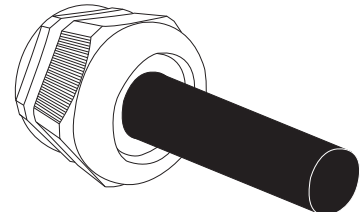
<p>1. Remove compression nut</p> 	<p>2. Pull out center gasket</p> 
<p>3. Slide compression nut over breakout, compress gasket to slide over breakout. Leaving protective polly tubing on will simplify this procedure. Be careful not to damage the fiber connectors.</p> 	<p>4. Gasket needs to be 1" behind heat shrink tube.</p> 
<p>5. Carefully feed fiber and power conductors into the OVP box and tighten the compression nut.</p> 	

Color coding (2 X 4 shown)

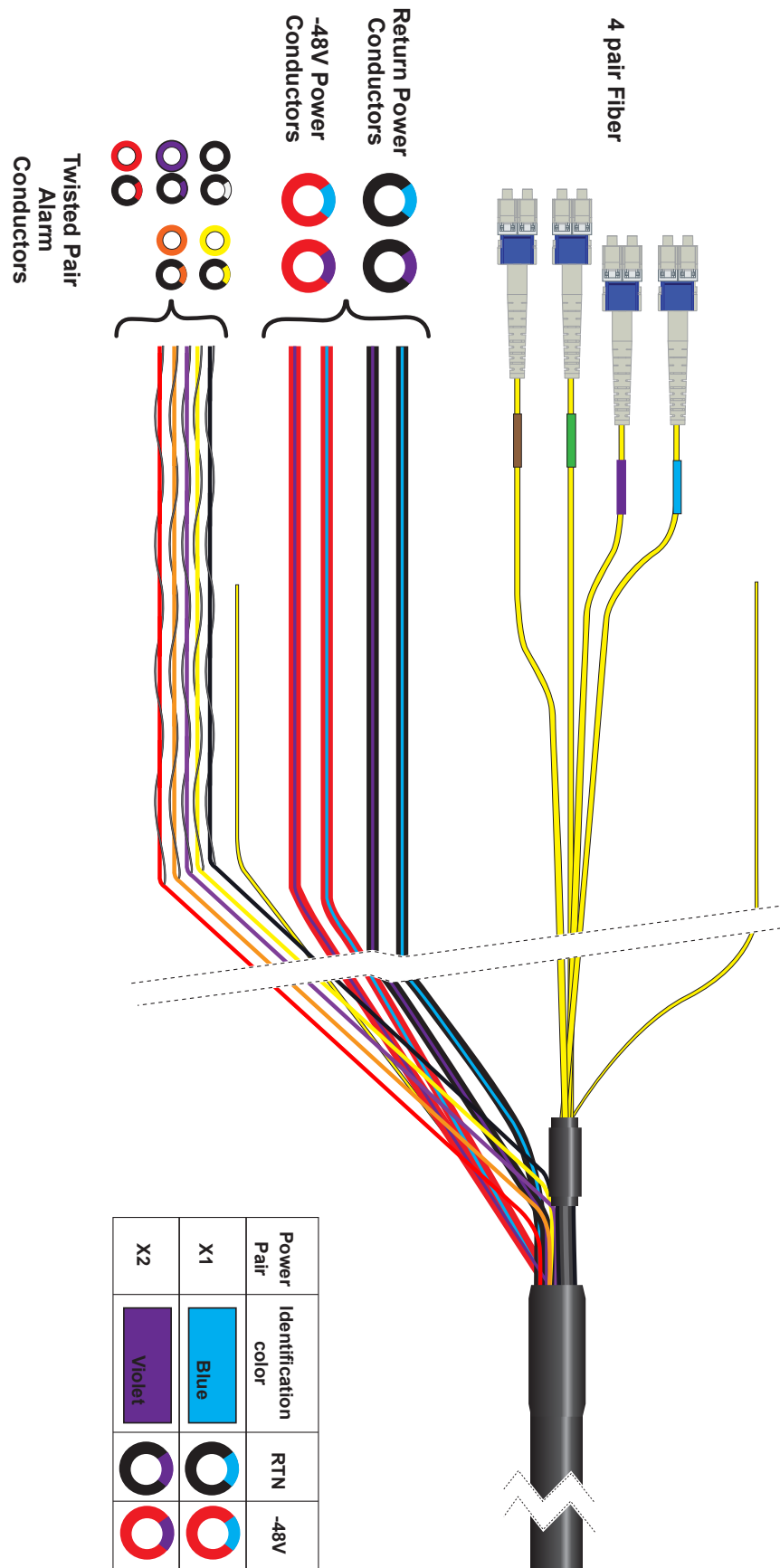

Color coding (4 X 8 shown)

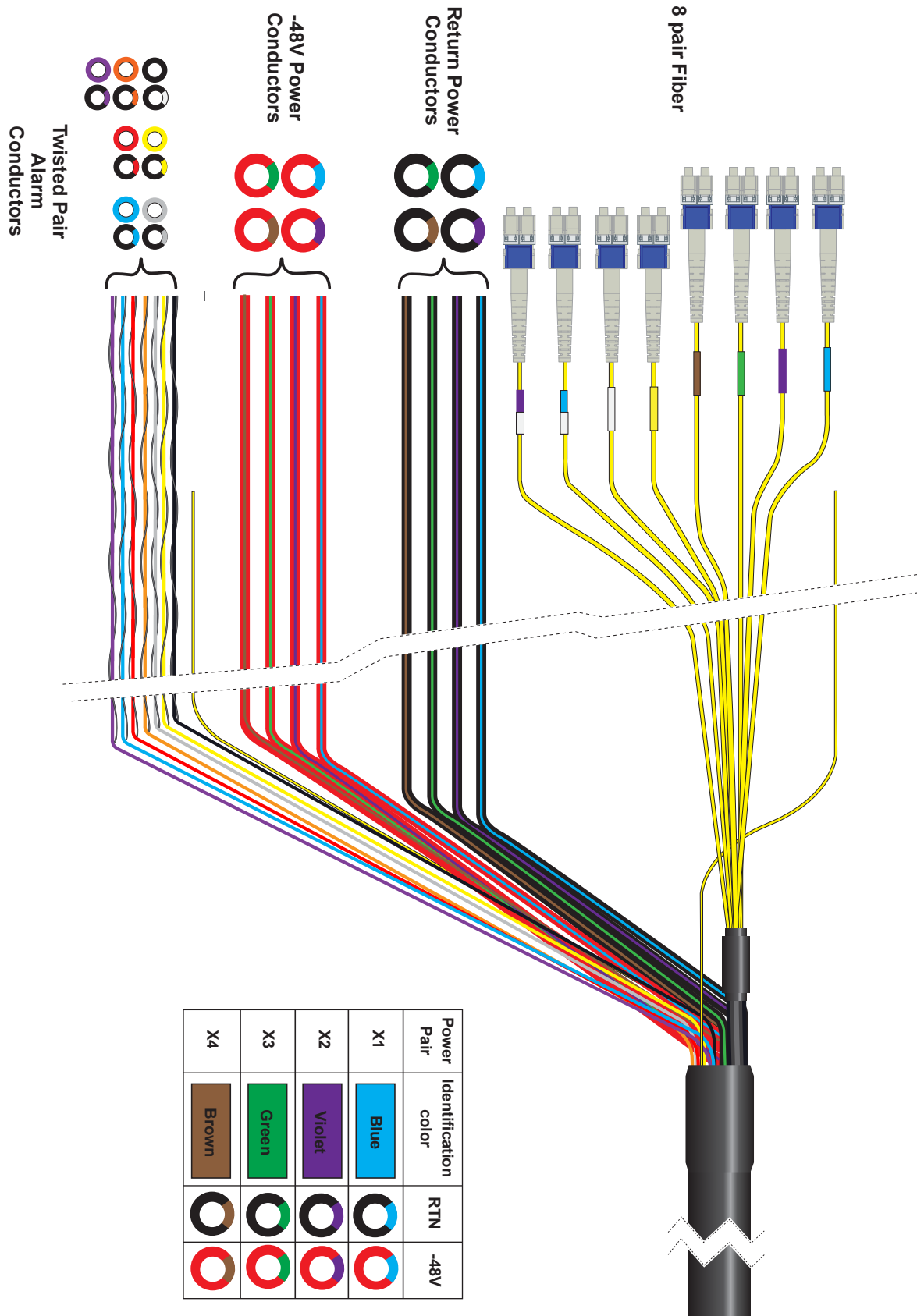

Color coding (6 X 12 shown)

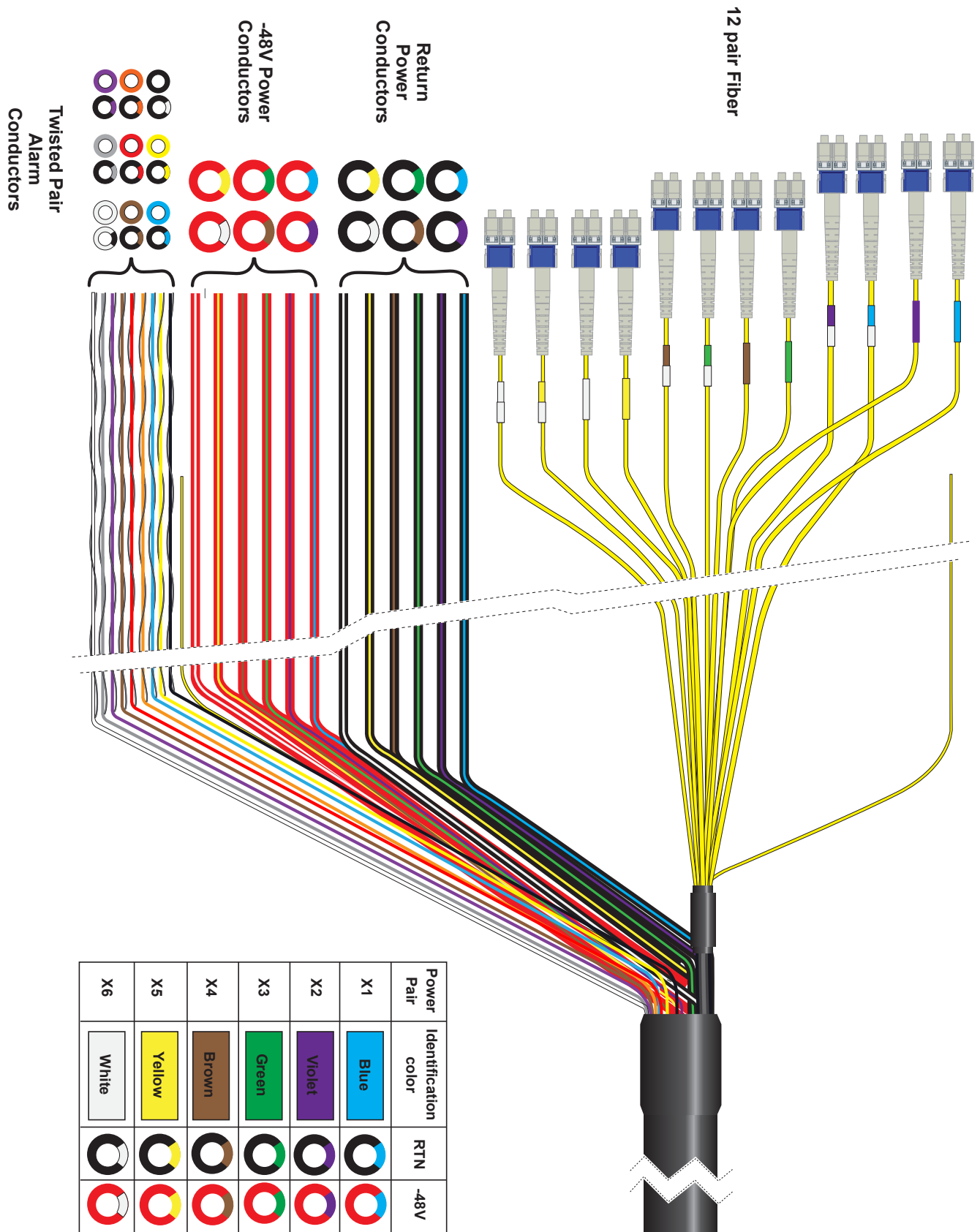

Grounding

Removing Jacketing for Grounding Kit installation

1. Score the jacketing 360°
2. Measure 2 inches (51 mm) and repeat
3. Identify where the aluminum shielding overlaps, this will feel like a flat spot in the cable
4. With a knife flat on the cable remove a section of jacketing between score marks
5. Lift edge of jacketing with knife tip
6. Grab lifted edge of jacketing with a pair of pliers and roll on the cable
7. Remove excess adhesive with a piece of emery cloth



Scan to view video

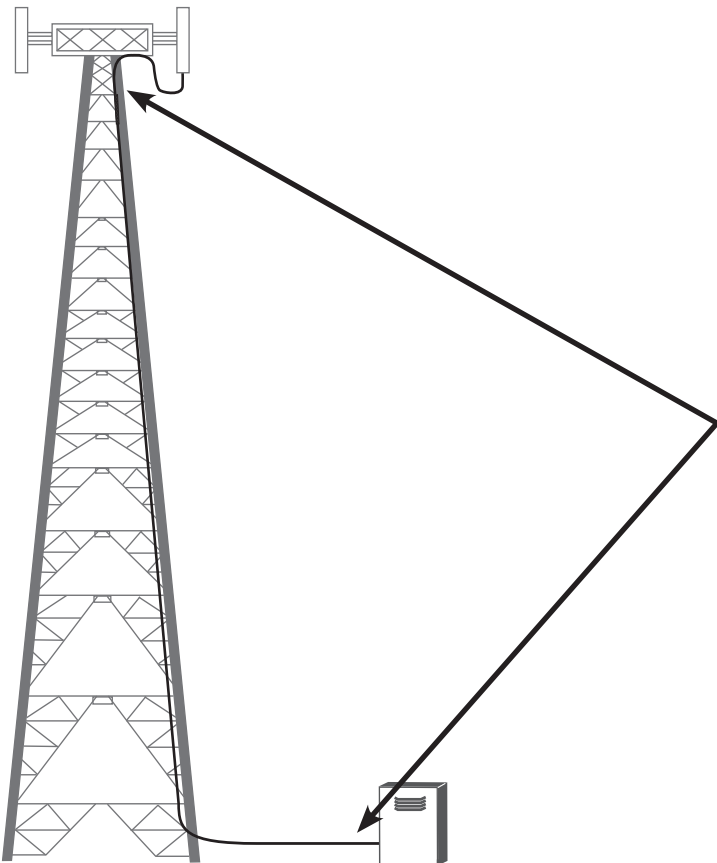









Ground Kit UG12158-15B4-T is a universal solution for all HFF trunk cables.
Only use Tin Plated grounding kits

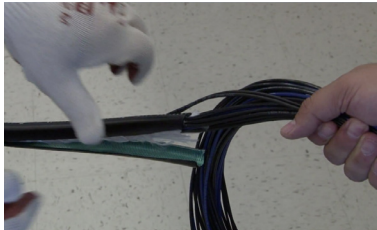

Ground kits required at the top and bottom before entering the shelter / cabinet

Excess Cable Management

If length of cable installed needs to be adjusted you can split the cable at the BBU end using the process below and then coiling the excess fiber subunits in a storage box. Fiber management trays are available to manage any excess fiber length in the breakouts at the BBU.

<p>1. Mark cutback length</p> 	<p>2. Notch Armor using flush cutter in-line with Kevlar strings</p> 
<p>3. Place Rip Cord in Notches'</p> 	<p>4. Pull Rip Cord Parallel to Cable (while supporting breakout)</p> 
<p>5. Stop at Length Marker</p> 	<p>6. Separate Armor</p> 
<p>7. Cut Armor Using Side Cutter</p> 	<p>8. Remove Water Blocking Tape</p> 
<p>9. Remove Excess Rip Cord</p> 	<p>10. Apply Electrical Tape to Protect Breakout</p> <p>NOTE: Remember to slide identifier labels down the power conductors before trimming the cable to it's final length</p> 



Scan to view video



Cable Splitter tool
Part Number:
FA-RCRT-PD



Excess Fiber storage Box
Part Number:
FE-14126-E



Fiber management tray, Part Number:
FE-14192-IR



Click here for video

Installation Check List

- Jumpers are properly support to prevent strain on fiber during severe weather
- Bend radius minimums haven't been exceeded
- CommScope FiberFeed® approved installation accessories are used
- Maximum hanger spacing of 0.9 m (3 ft) - 1.2 m (4 ft) is maintained
- Visually inspected end face for residual dirt and damage
- Avoid migration of contaminations from one connector to another
- Check continuity by using LED or lazer light source from one end face and look for light from other end to identify any broken fiber (Do not look directly at cable with laser source)
- Fiber Connections are engaged and the sectors are consistent with requirements
- Cable serial number has been documented in the closeout paperwork and a copy has been left on-site

CommScope

1100 CommScope Place SE P.O. Box 339, Hickory, NC 28603-0339
 (828) 324-2200 (800) 982-1708
www.commscope.com/andrew

Customer Service 24 hours

North America: +1-800-255-1479 (toll free)
 Any country: +1-779-435-6500
 email: acicustomersupportcenter@commscope.com

Notice: CommScope disclaims any liability or responsibility for the results of improper or unsafe installation, inspection, maintenance, or removal practices.
 Aviso : CommScope no acepta ninguna obligación ni responsabilidad como resultado de prácticas incorrectas o peligrosas de instalación, inspección, mantenimiento o retiro.
 Avis : CommScope décline toute responsabilité pour les conséquences de procédures d'installation, d'inspection, d'entretien ou de retrait incorrectes ou dangereuses.
 Hinweis: CommScope lehnt jede Haftung oder Verantwortung für Schäden ab, die aufgrund unsachgemäßer Installation, Überprüfung, Wartung oder Demontage auftreten.
 Atenção: A CommScope abdica do direito de toda responsabilidade pelos resultados de práticas inadequadas e sem segurança de instalação, inspeção, manutenção ou remoção.
 Avvertenza: CommScope declina eventuali responsabilità derivanti dall'esecuzione di procedure di installazione, ispezione, manutenzione e smontaggio improprie o poco sicure.
 注意: CommScope 公司申明對於不恰當或不安全的安裝、檢驗、維修或拆卸操作所導致的后果不負責 何義務和責任

© 2014 CommScope