

HXT-B6HVA0050FN000



NOVUX™ Hardened Indexing Terminal, 24 Fiber with 3 Fiber multi-use ports, 1 Reverse HMFOC port, Dielectric flat loose tube, 50 ft/15 m HMFOC plug (female/no pin) tail

- NOVUX™ Hardened Multi-fiber Terminals incorporate hardened connector technology that is designed to withstand the rugged outside plant environment
- Hardened connectors are factory-integrated and environmentally sealed for use in optical drop cable deployments
- Plug and play adapter ports ensure rapid cable installment in the outside plant access section of the network
- NOVUX™ HXT fiber indexing terminals are available with 1:4 or 1:8 splitter and optional multi-use ports, Index Only and Index Branching 2 to 6 fiber solutions
- Available with flat dielectric and flat toneable/locatable dielectric cable
- NOVUX™ smaller terminal size for aesthetics and allowing installation in constrained spaces
- NOVUX™ terminals are available in Black (RAL# 9005) or Gray (RAL# 7035)
- CommScope Product ID plate with QR code link to product documents and C-Track

Product Classification

| | |
|-------------------------------|---|
| Regional Availability | Asia EMEA Latin America North America |
| Product Type | Access terminal, without splitter/tap |
| Product Brand | NOVUX™ |
| Product Series | HXT |
| Minimum Order Quantity | 1 |

General Specifications

| | |
|-------------------------------|--|
| Cable Type | Dielectric - Flat - Loose Tube |
| Cable, quantity | 1 |
| Distribution Type | 3 ports |
| Drop Port Type | Hardened full-size SC/APC |
| Drop Port, quantity | 3 |
| Enclosure Color | Black (RAL 9005) |
| Forward Port Type | Hardened multi-fiber (HMFOC) jack, male/pinned |
| Forward Port, quantity | 2 |
| Mounting | Handhole Pedestal Pole Strand |
| Port Type | Hardened full-size SC/APC |
| Port, quantity | 6 |

HXT-B6HVA0050FN000

| | |
|-------------------------------|--|
| Reverse Port Type | Hardened multi-fiber (HMFOC) jack, male/pinned |
| Reverse Port, quantity | 1 |
| Stub Type | Hardened multi-fiber (HMFOC) plug, female/no pin |

Dimensions

| | |
|-----------------------------|-------------------------------|
| Height | 80 mm 3.15 in |
| Width | 157 mm 6.19 in |
| Length | 192 mm 7.58 in |
| Cable Length, stub | 50 ft (15 m) |
| Cable Outer Diameter | 4.3 x 8.0 mm (0.17 x 0.31 in) |

Dimension Drawing

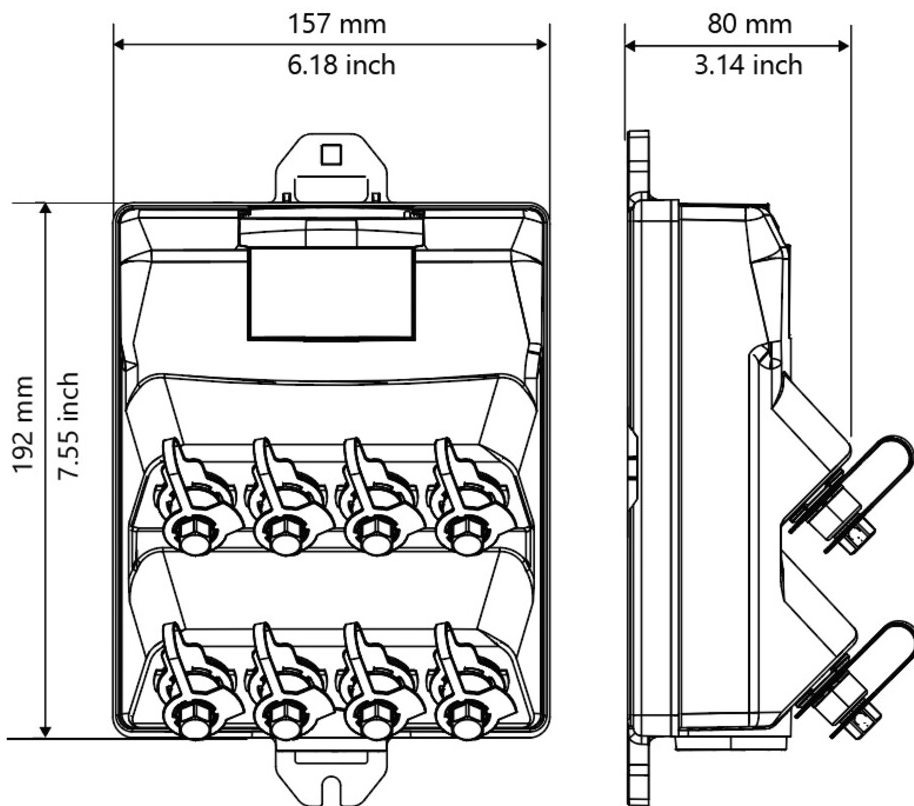

Port Configuration

HXT-B6HVA0050FN000

| NOVUX HT | TECHNOLOGIES AVAILABLE | SMALL | MEDIUM | LARGE |
|------------|------------------------|--------------------------------------|------------------------|-----------------------------|
| HXT Series | Fiber indexing | 12 fiber index only, 1f | 12 fiber 1:4 | 12 fiber 1:8 |
| | | 12 fiber index only, 2f | 12f multi-use 2f + 1:4 | 12 fiber multi-use, 3f +1:4 |
| | | 12 fiber index only, 3f | 24f multi-use 2f | 12 fiber multi-use, 4f +1:4 |
| | | 12 fiber index only, 4f | 24f multi-use 3f | 12 fiber multi-use, 2f +1:8 |
| | | 12 fiber multi-use, 2f | 24f multi-use 4f | |
| | | 12 fiber branching, 2 to 6f per port | | |

Ordering Tree



Material Specifications

Enclosure Material Type Hardened plastic

Optical Specifications

Fiber Type G.657.A1/A2

Operating Wavelength Range 1260 – 1635 nm

Attenuation Single Ports, maximum 0.4 dB

Attenuation Cable Coefficient, maximum 0.30 dB/km @ 1550 nm | 0.40 dB/km @ 1310 nm

Insertion Loss, Stub Connector, maximum 0.65 dB

Return Loss, Connector, typical 65 dB

HXT-B6HVA0050FN000

Environmental Specifications

| | |
|--------------------------------|---|
| Operating Temperature | -40 °C to +65 °C (-40 °F to +149 °F) |
| Relative Humidity | 5%–100%, condensing |
| Environmental Space | Above ground Below ground |
| Qualification Standards | IEC 60529, IP68 + 2 m waterhead IEC 61753-1, category G |
| UV Resistance | UV stabilized |

Packaging and Weights

| | |
|---------------------------|--------------|
| Packaging quantity | 1 |
| Packaging Type | Box Coiled |

Regulatory Compliance/Certifications

| Agency | Classification |
|---------------|--|
| CHINA-ROHS | Below maximum concentration value |
| ISO 9001:2015 | Designed, manufactured and/or distributed under this quality management system |
| REACH-SVHC | Compliant as per SVHC revision on www.commscope.com/ProductCompliance |
| ROHS | Compliant |
| UK-ROHS | Compliant |

