

NDX-B5BHM0U-A0450F



Fiber Indexing Terminal, 5F Branching, Dielectric Loose Tube Cable, 450 Feet

- Fiber Indexing terminals are access terminals using hardened connectivity technology that withstand the rugged outside plant environment
- Fiber Indexing terminals eliminate splicing and use 12-strand fiber cable in a daisy-chain topology, reducing the total required cable length by up to 70%
- Hardened adapters are factory-terminated and environmentally sealed to ensure rapid plug-and-play drop cable installations

Product Classification

Regional Availability	North America
Product Type	Access terminal, indexed without splitter/tap
Product Series	NDX

General Specifications

Cable Type	Dielectric - Flat - Loose Tube
Cable, quantity	1
Distribution Type	5 ports
Enclosure Color	Black
Mounting	Handhole Pedestal Pole
Port Type	Hardened multi-fiber (HMFOC) jack, male/pinned
Port, quantity	5
Splitter, quantity	0
Stub Type	Hardened multi-fiber (HMFOC) plug

Dimensions

Height	297.8 mm 11.724 in
Width	130.3 mm 5.13 in
Depth	90.4 mm 3.559 in
Cable Length, stub	450 ft (137 m)
Cable Outer Diameter	4.5 x 8.1 mm (0.18 x 0.32 in)

Dimension Drawing

NDX-B5BHM0U-A0450F

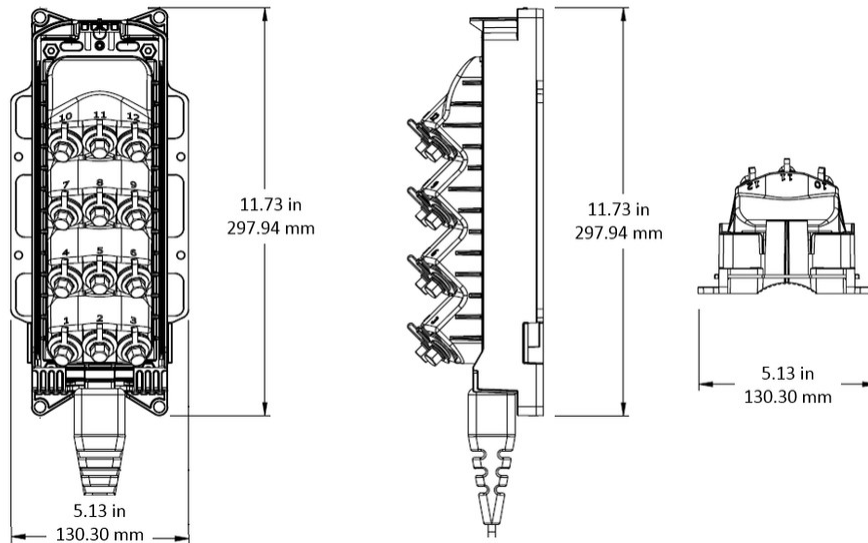

Ordering Tree



Material Specifications

Enclosure Material Type

Gasketed hardened plastic

NDX-B5BHM0U-A0450F

Optical Specifications

Fiber Type	G.652.D
Operating Wavelength Range	1260 – 1635 nm
Attenuation Cable Coefficient, maximum	0.30 dB/km @ 1550 nm 0.40 dB/km @ 1310 nm
Attenuation Terminal Connectors, maximum	0.45 dB
Directivity, minimum	60 dB
Insertion Loss, Stub Connector, maximum	0.45 dB
Insertion Loss, Stub Connector, typical	0.16 dB
Insertion Loss, Terminal Connector, typical	0.16 dB
Return Loss, Connector, minimum	65 dB

Environmental Specifications

Operating Temperature	-40 °C to +70 °C (-40 °F to +158 °F)
Relative Humidity	5%–100%, condensing
Environmental Space	Above ground Below ground Buried
Flammability Rating	UL 94 V-0
Qualification Standards	IEC 60529, IP68 + 2 m waterhead NEMA, Type 6 + 10 ft waterhead Telcordia GR-3120-CORE Telcordia GR-326-CORE Telcordia GR-771-CORE
UV Resistance	UV stabilized

Packaging and Weights

Included	Enclosure (1) Universal mounting bracket (1)
Packaging quantity	1
Packaging Type	Box Carton
Weight, without cable	1 kg 2.205 lb

Regulatory Compliance/Certifications

Agency	Classification
CHINA-ROHS	Above maximum concentration value
ISO 9001:2015	Designed, manufactured and/or distributed under this quality management system
REACH-SVHC	Compliant as per SVHC revision on www.commscope.com/ProductCompliance
ROHS	Compliant/Exempted
UK-ROHS	Compliant

NDX-B5BHM0U-A0450F



Included Products

- MST-UMB-MINI - DLX® Mini-MST, Fiber Optic Universal Mounting Bracket

MST-UMB-MINI



DLX® Mini-MST, Fiber Optic Universal Mounting Bracket

Product Classification

Regional Availability	EMEA Latin America North America
Product Type	Mounting bracket
Product Brand	DLX®
Product Series	Mini-MST

General Specifications

Color	Black
--------------	-------

Environmental Specifications

Environmental Space	Outdoor
----------------------------	---------

Packaging and Weights

Packaging quantity	1
Packaging Type	Bag Carton

Regulatory Compliance/Certifications

Agency	Classification
CHINA-ROHS	Below maximum concentration value
REACH-SVHC	Compliant as per SVHC revision on www.commscope.com/ProductCompliance
ROHS	Compliant
UK-ROHS	Compliant

